

# Geosemantic Snapping for Sketch-Based Modeling

Alex Shtof



Tel Aviv University

Alexander Agathos



West University of Timișoara

Yotam Gingold



George Mason University

Ariel Shamir



The Interdisciplinary Center, Herzliya

Daniel Cohen-Or



Tel Aviv University

# 3D Modeling



[Rip Caswell]

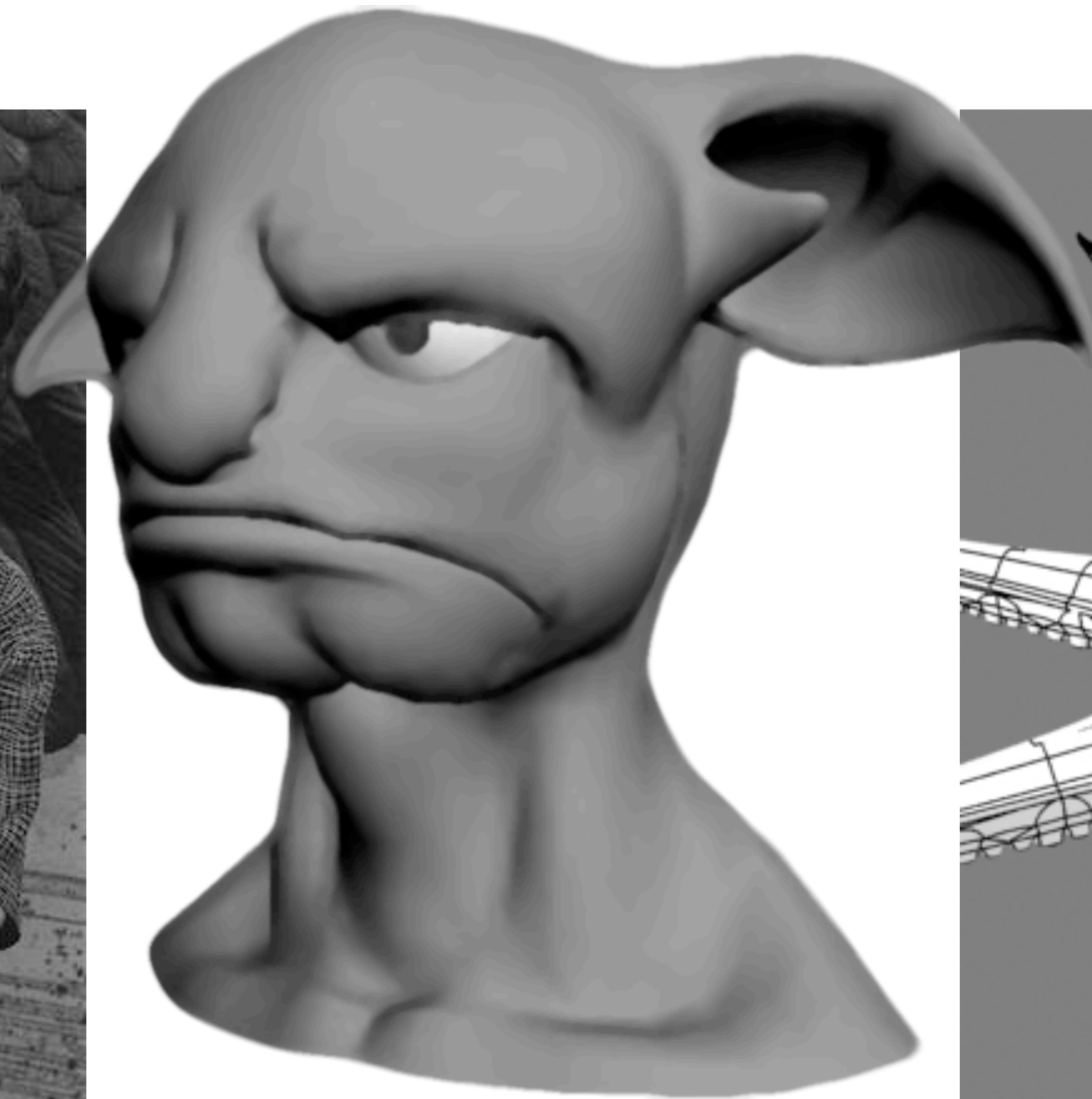

[Malanjo]

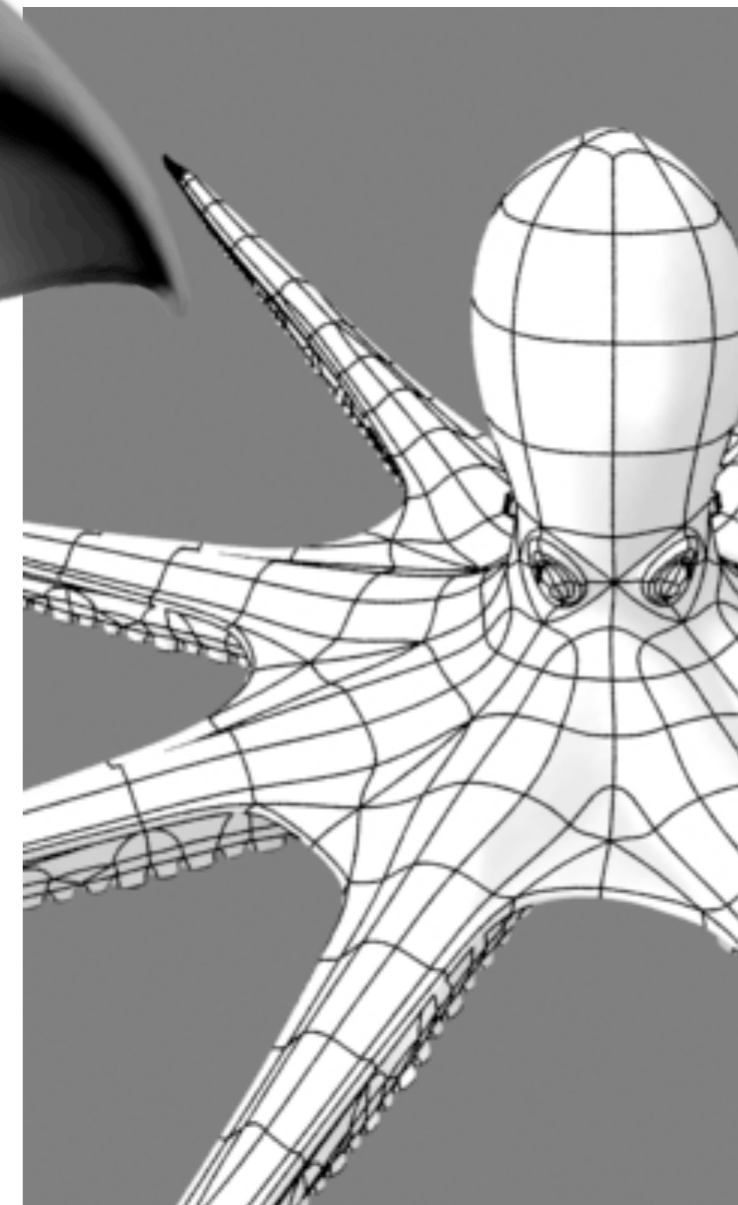

[NoneCG]

# Sketches

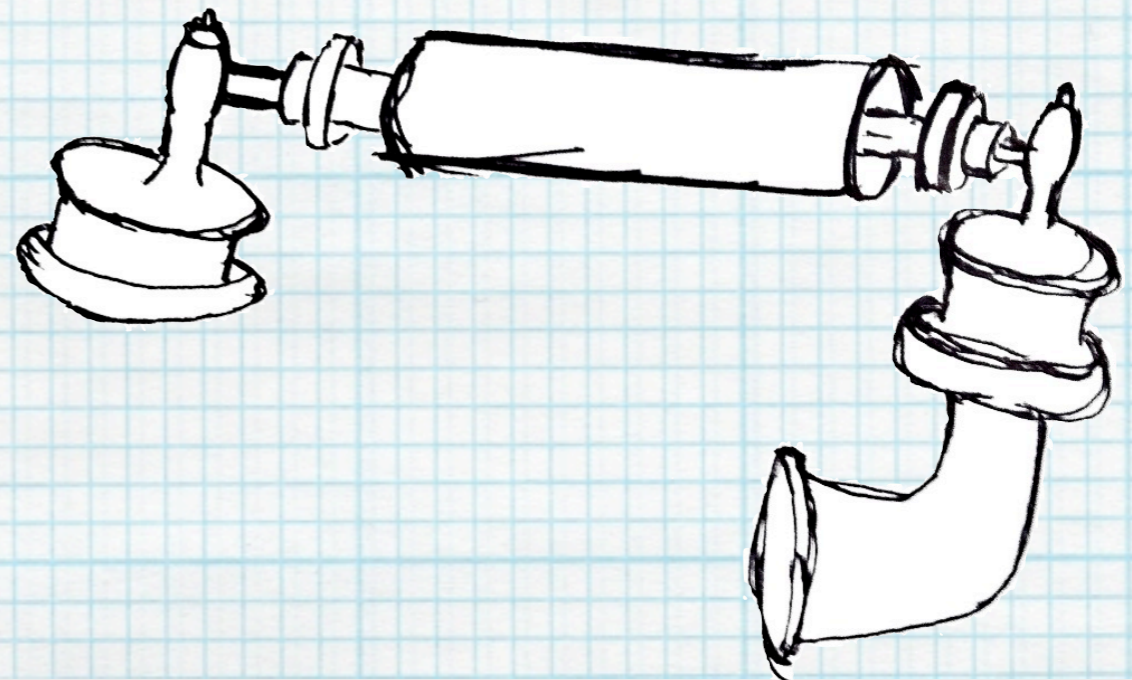
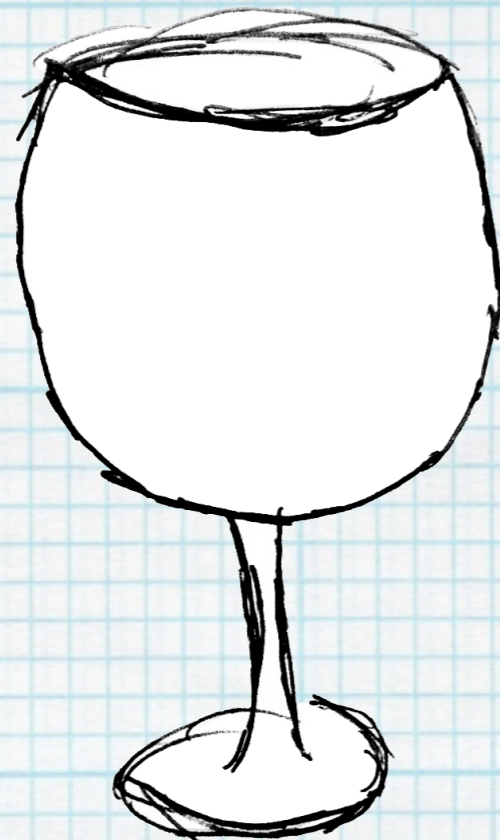
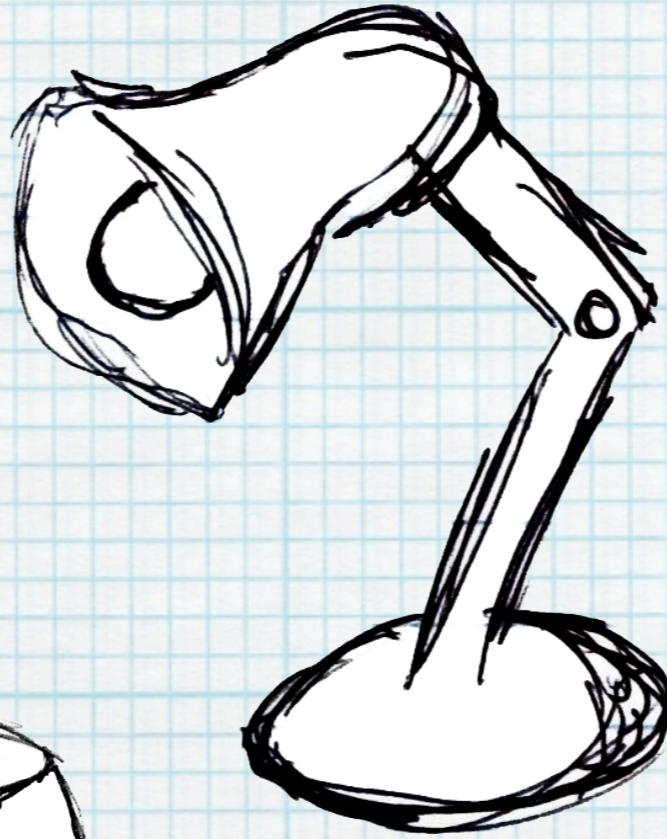
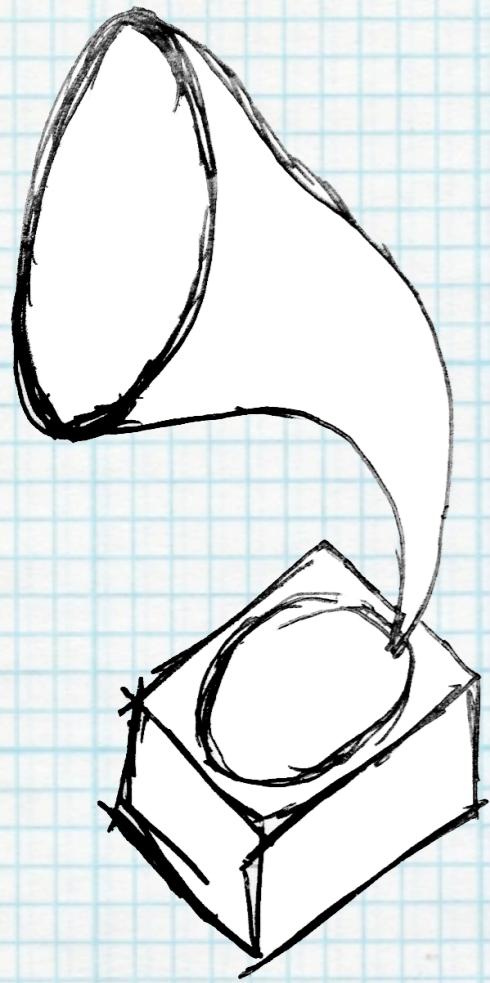

# Challenges

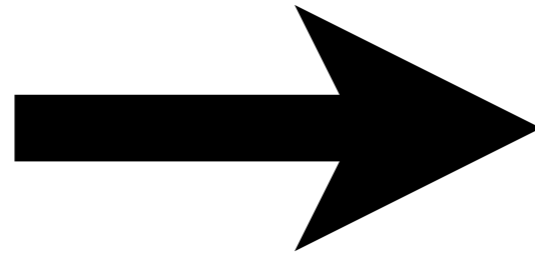
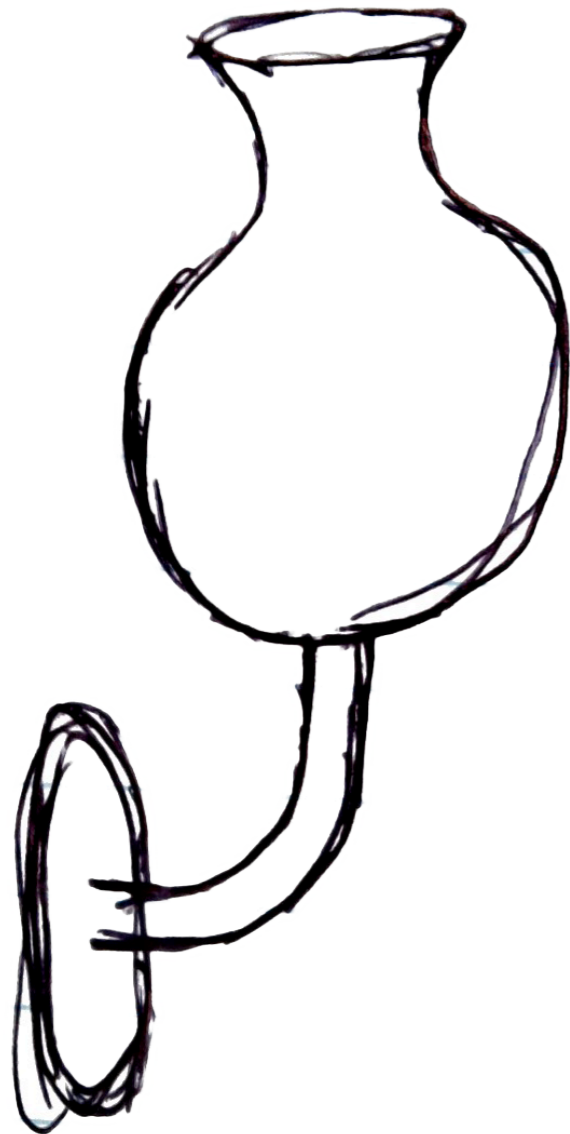

# Challenges

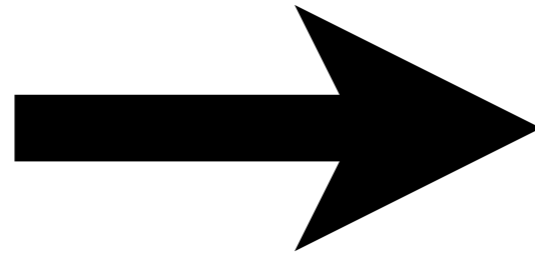
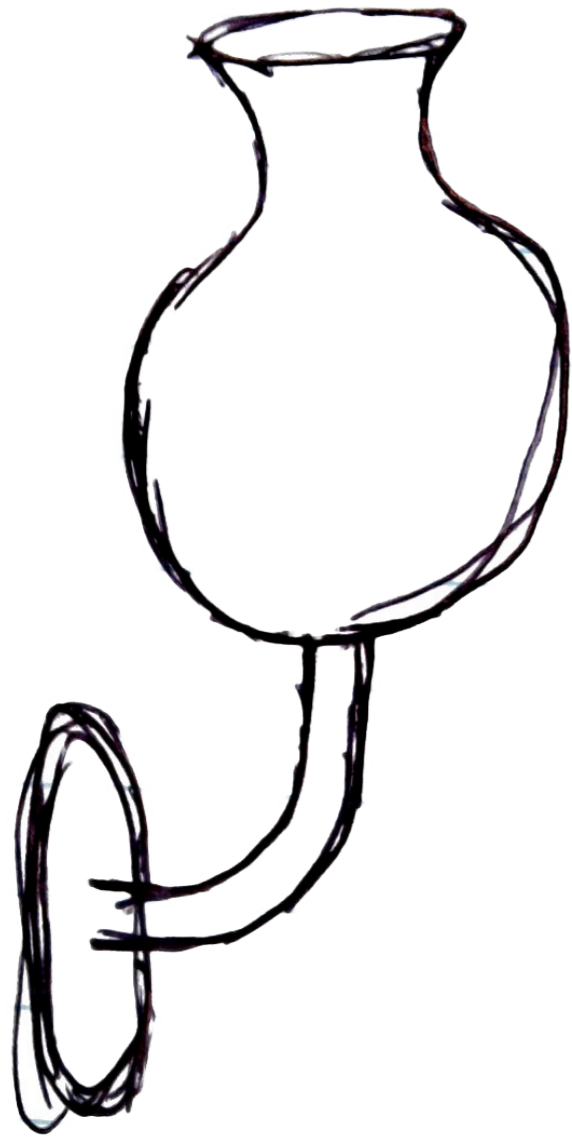

Segmentation



# Challenges

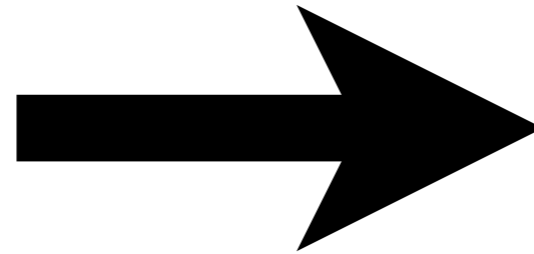
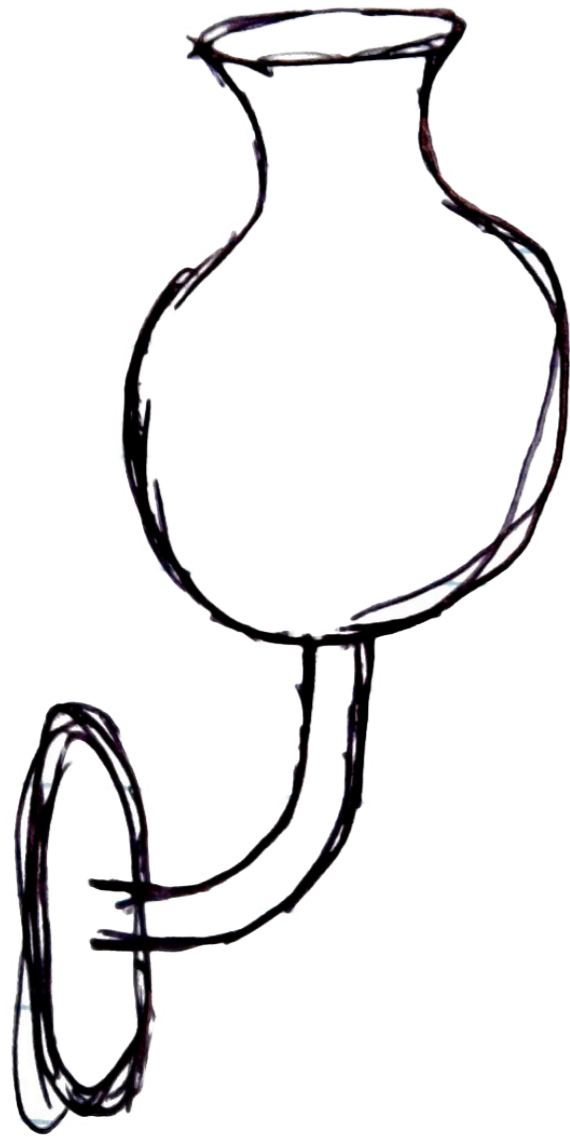

Segmentation  
Recognition

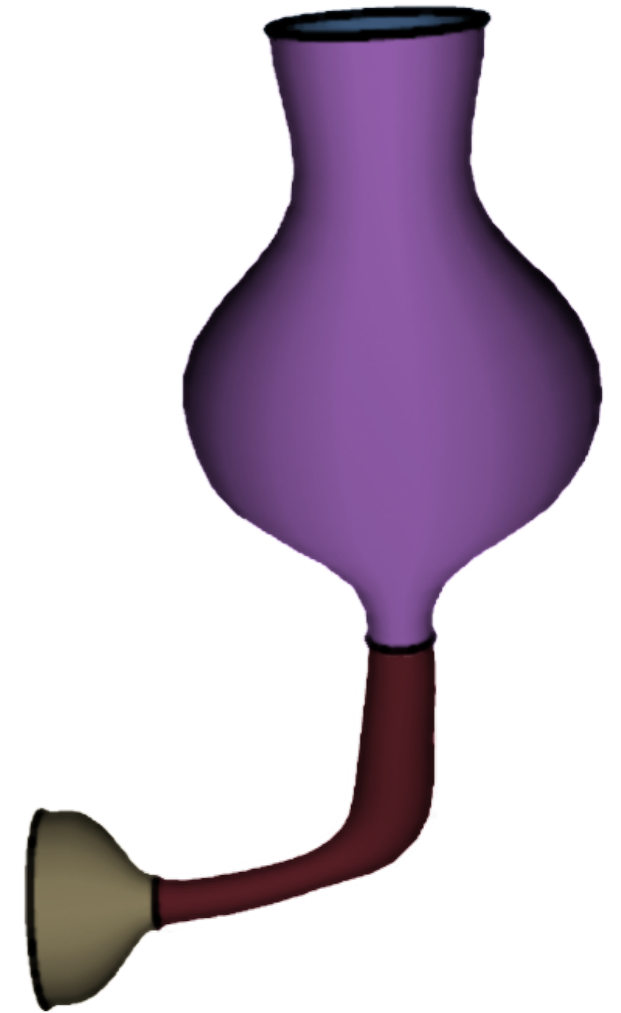

# Challenges

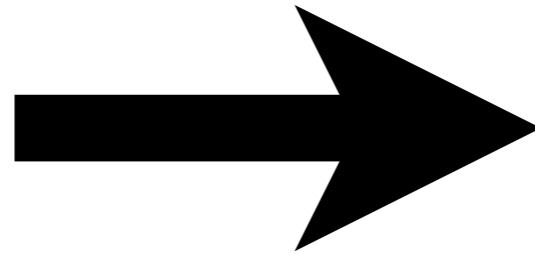
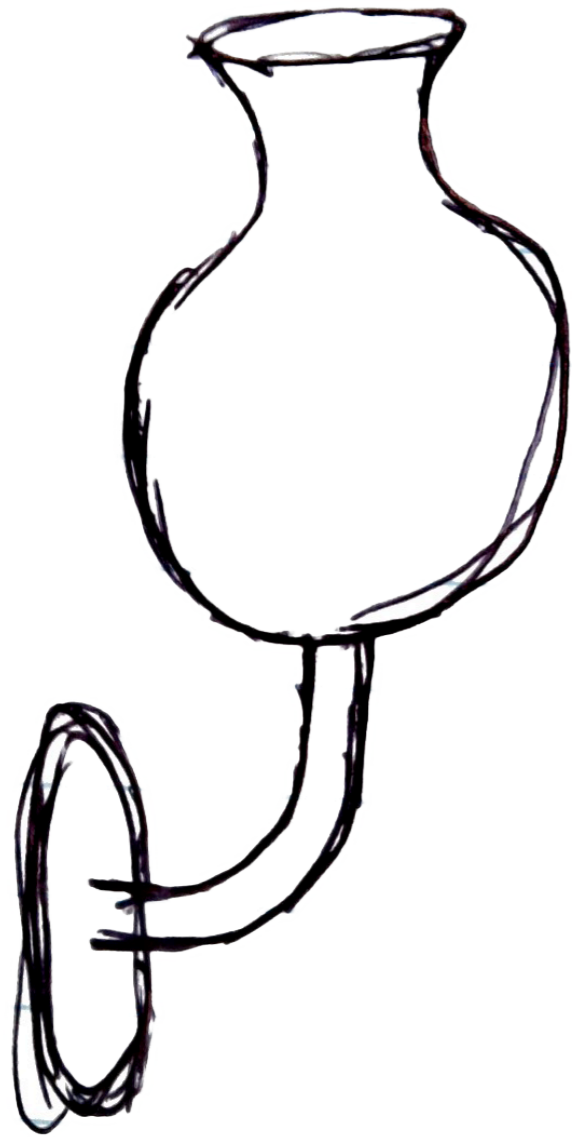

Segmentation  
Recognition  
Positioning

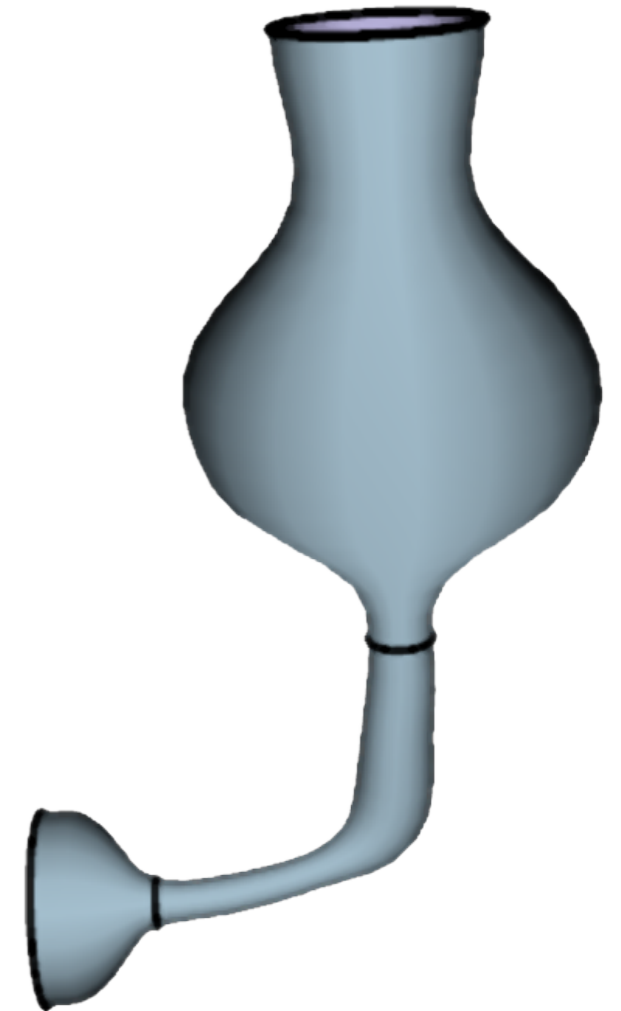

# Challenges

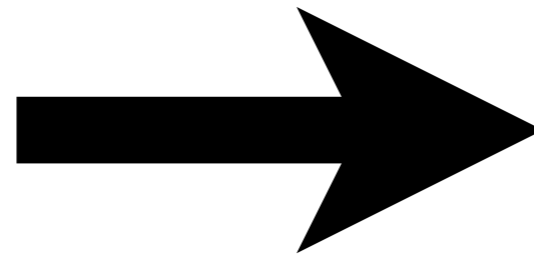
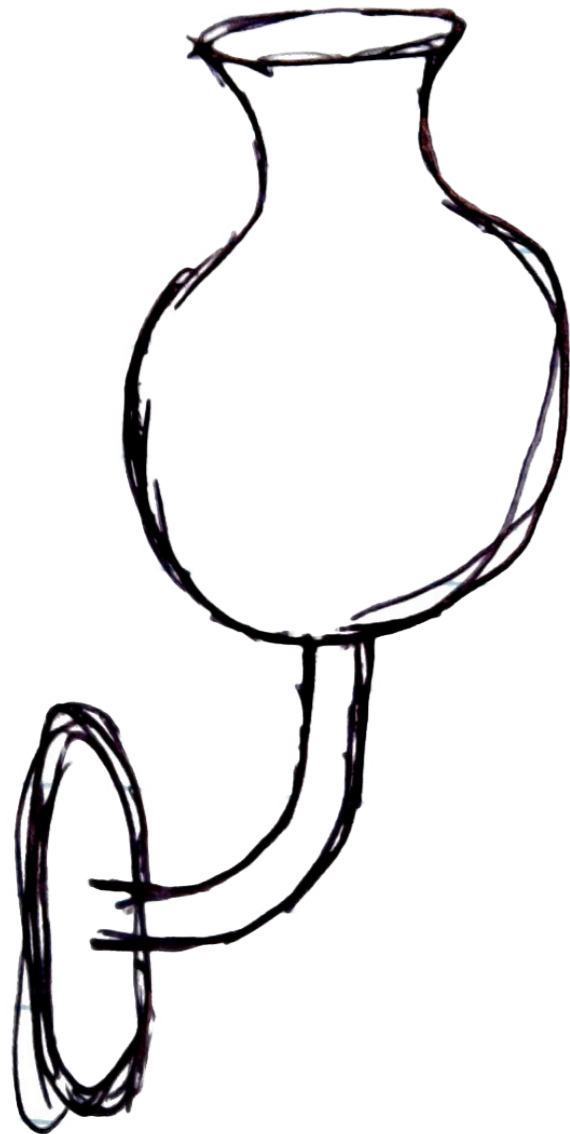

Segmentation  
Recognition  
Positioning

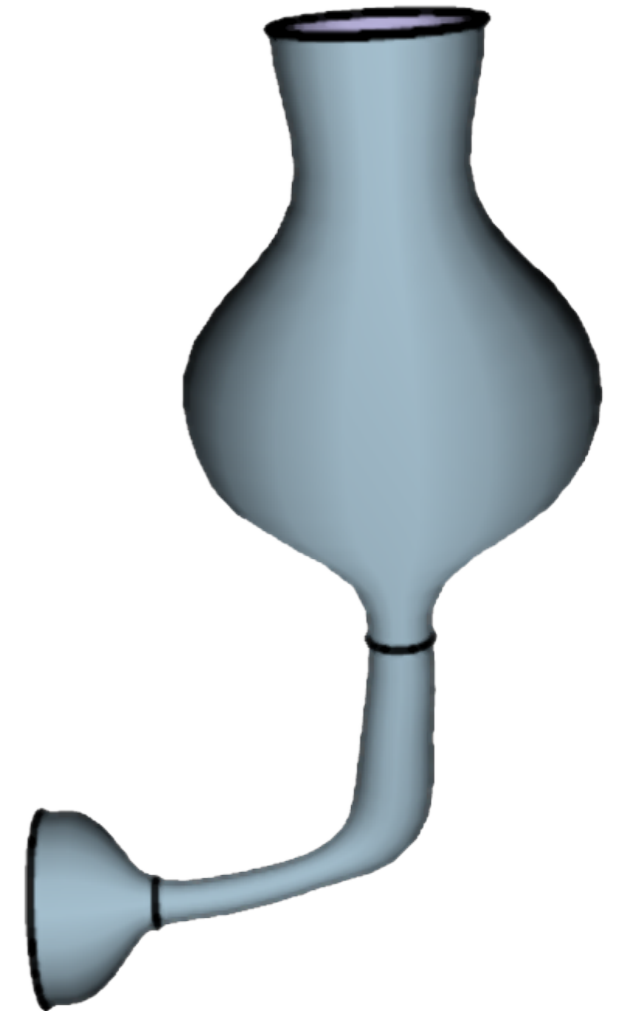

An automatic solution entails solving a **complex, non-convex** optimization problem with **many local minima**.



# Interactive Approach

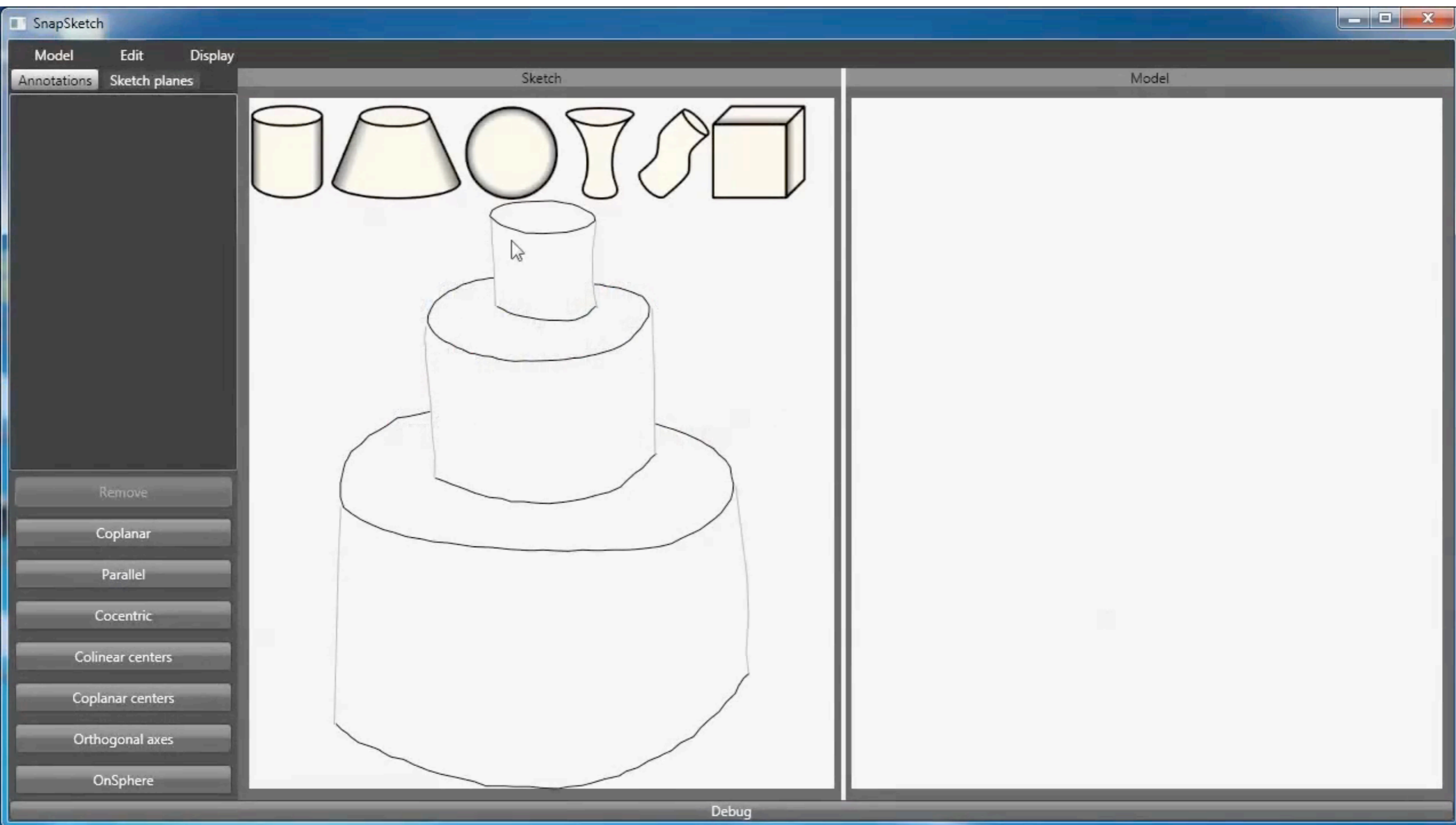

# Our Solution

Separate the problem into **semantic** and **geometric** tasks.

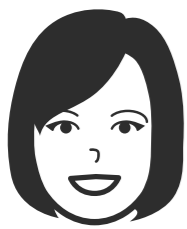

**semantic:** interpreting the sketch's individual strokes and parts

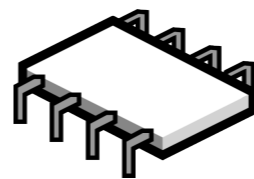

**geometric:** fitting and reconstructing precise geometry

# Related Work

## Image-Based Modeling

- [Gingold et al. 2009]
- [Lau et al. 2010]
- [Tsang et al. 2004]
- [Xu et al. 2011]
- [Debevec et al. 1996]
- [Sinha et al. 2008]
- [van den Hengel 2007]

## Primitives and Constraints

- [Sutherland 1963]
- [Igarashi 1998]
- [Li et al. 2011]
- [Zelevnik et al. 1996]
- [Pereira et al. 2003]

## Sketch-Based Modeling

- [Igarashi et al. 1999]
- [Pugh 1991]
- [Eggli et al. 1997]
- [Bae et al. 2008]
- [Schmidt et al. 2009]
- [Lipson and Shpitalni 1996]
- [Shesh and Chen 2004]
- [Chen et al. 2008]
- [Ouyang and David 2011]
- [LaViola and Zelevnik 2004]

# Related Work

## Image-Based Modeling



[Sinha et al. 2008]

## Sketch-Based Modeling

- [Igarashi et al. 1999]
- [Pugh 1991]
- [Eggli et al. 1997]
- [Bae et al. 2008]
- [Schmidt et al. 2009]
- [Lipson and Shpitalni 1996]
- [Shesh and Chen 2004]
- [Chen et al. 2008]
- [Ouyang and David 2011]
- [LaViola and Zeleznik 2004]

## Primitives and Constraints

- [Sutherland 1963]
- [Igarashi 1998]
- [Li et al. 2011]
- [Zeleznik et al. 1996]
- [Pereira et al. 2003]

# Related Work

## Image-Based Modeling



[Sinha et al. 2008]

## Sketch-Based Modeling

- [Igarashi et al. 1999]
- [Pugh 1991]
- [Eggli et al. 1997]
- [Bae et al. 2008]
- [Schmidt et al. 2009]
- [Lipson and Shpitalni 1996]
- [Shesh and Chen 2004]
- [Chen et al. 2008]
- [Ouyang and David 2011]
- [LaViola and Zeleznik 2004]

## Primitives and Constraints

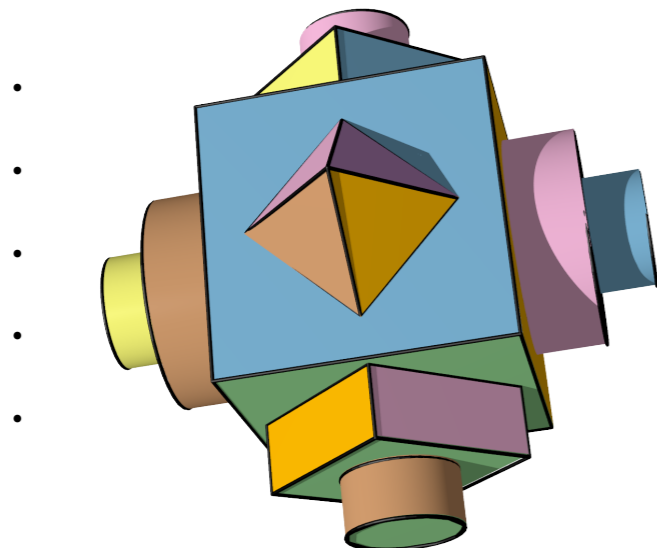

[Li et al. 2011]

# Related Work

## Image-Based Modeling



[Sinha et al. 2008]

## Sketch-Based Modeling

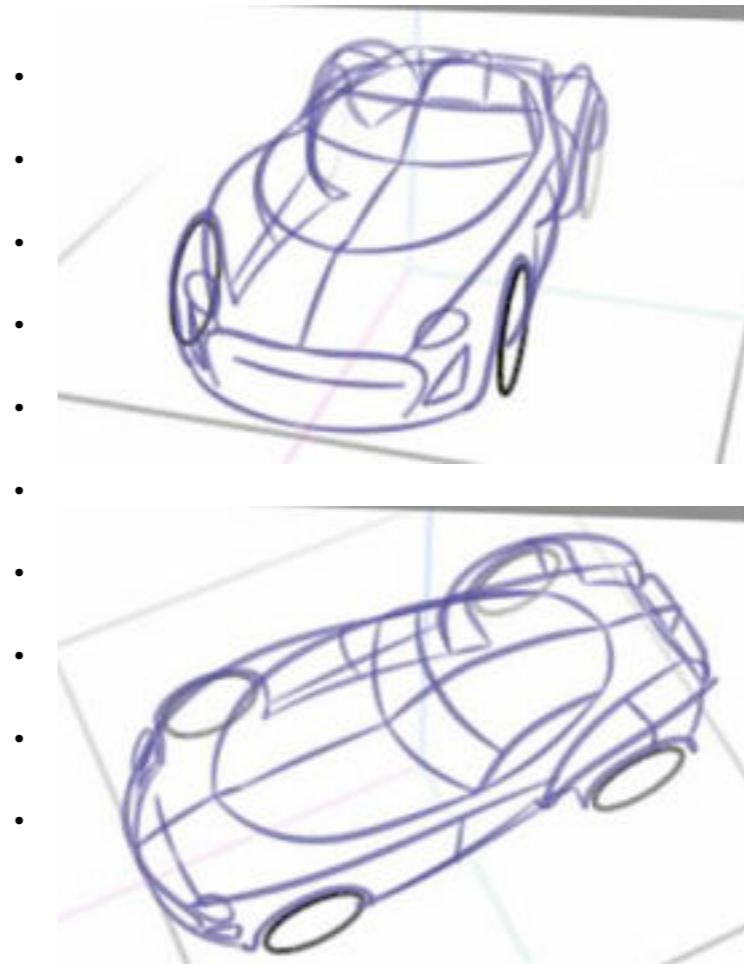

[Bae et al. 2009]

## Primitives and Constraints

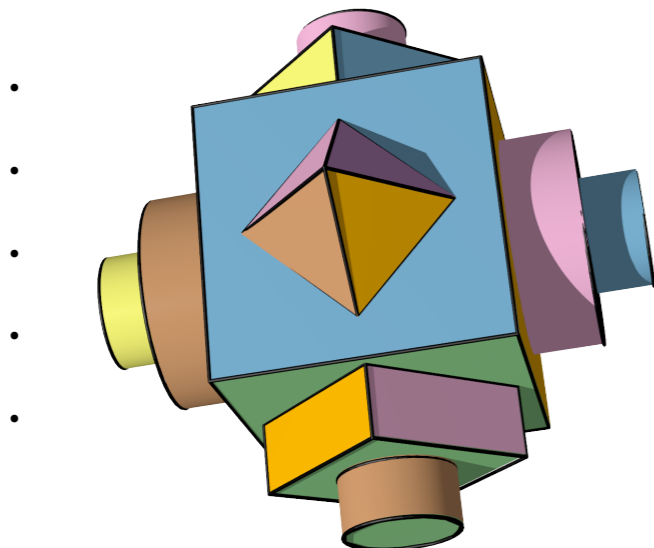

[Li et al. 2011]

# Overview



input sketch

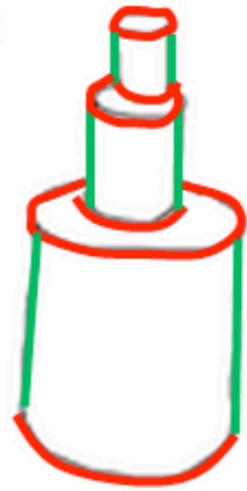

semantic classification

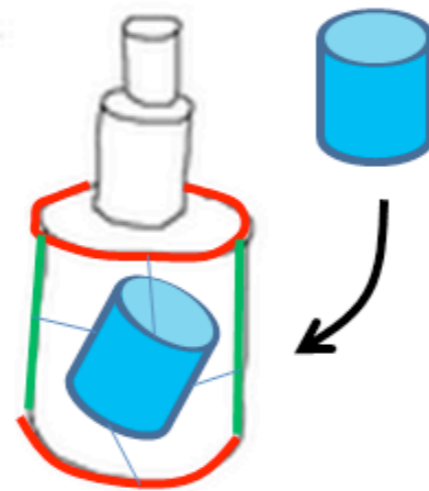

interactive matching



real-time snapping

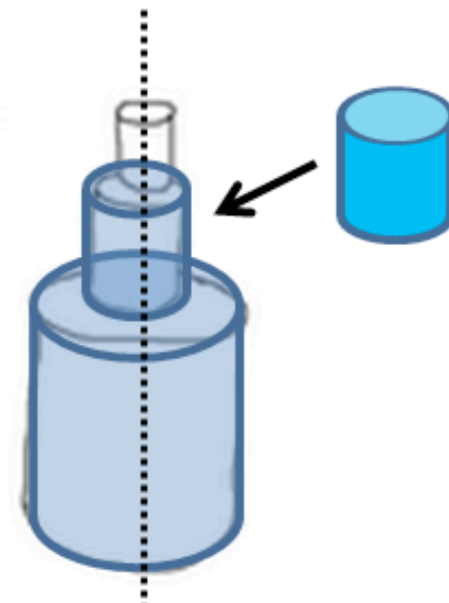

geosemantic snapping

# Primitives

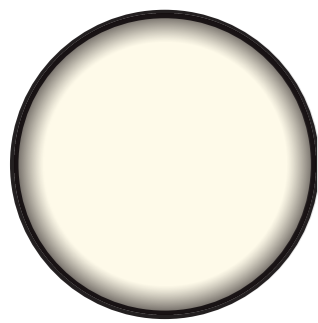

sphere

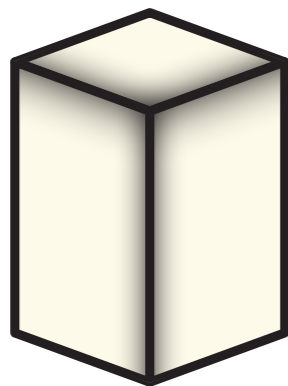

box

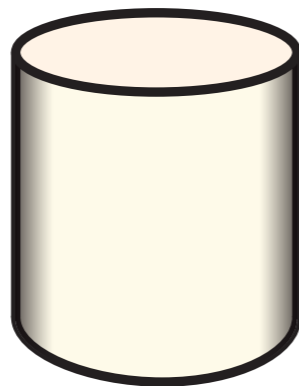

straight  
cylinder

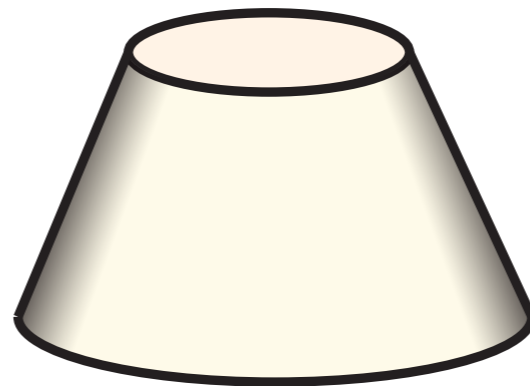

truncated cone

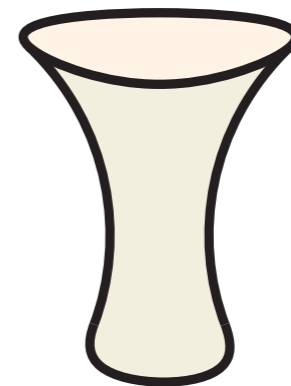

straight  
generalized  
cylinder

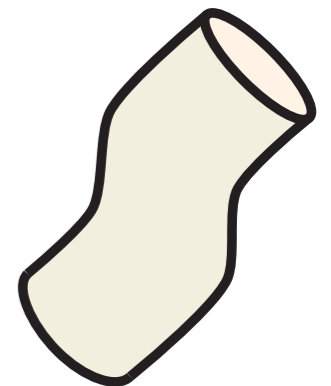

bent  
generalized  
cylinder



# Primitives: Feature Curves

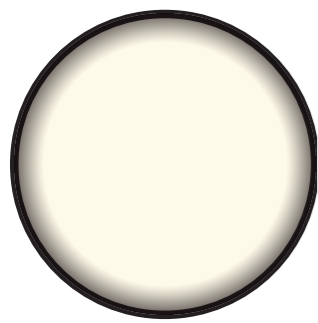

sphere

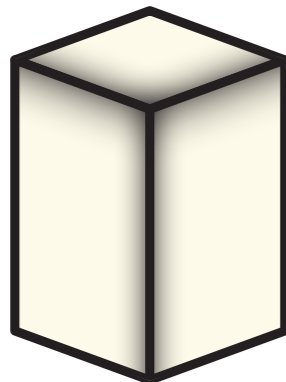

box

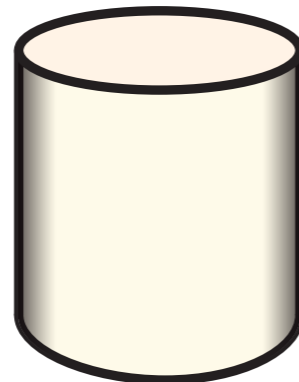

straight  
cylinder

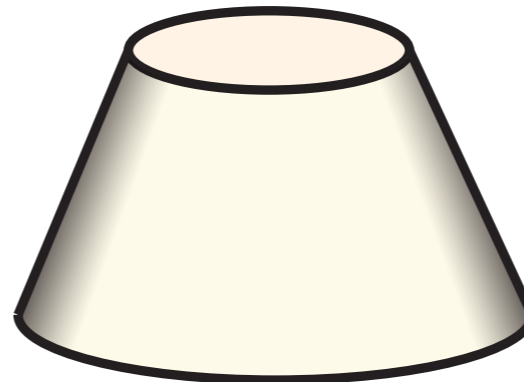

truncated cone

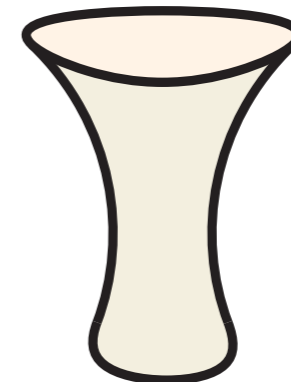

straight  
generalized  
cylinder

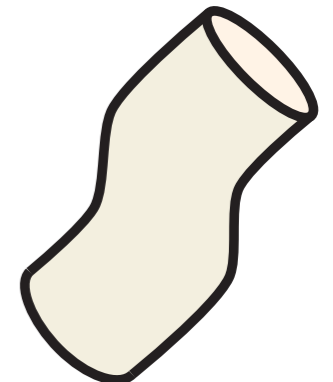

bent  
generalized  
cylinder

# Primitives: Feature Curves

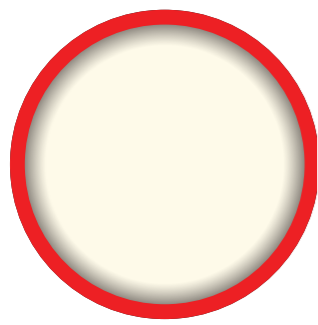

sphere

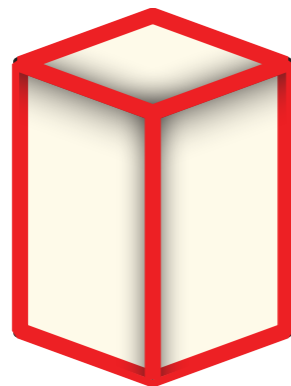

box

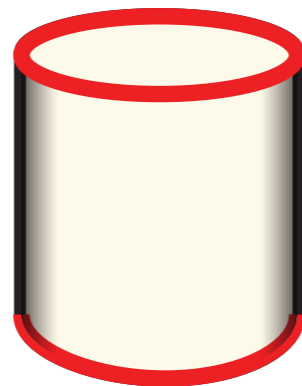

straight  
cylinder

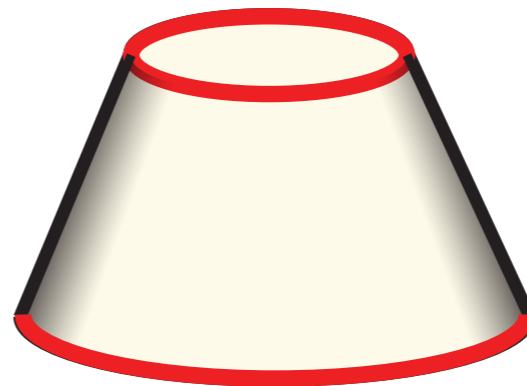

truncated cone

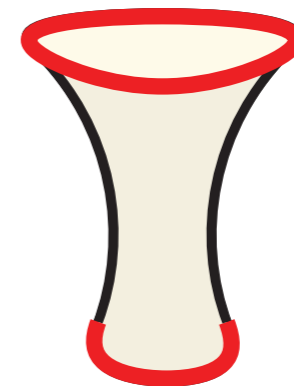

straight  
generalized  
cylinder

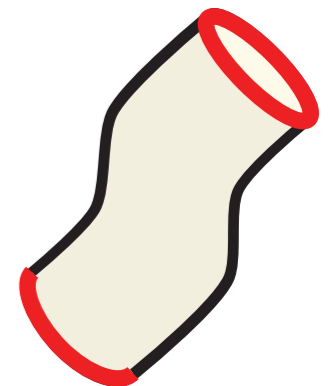

bent  
generalized  
cylinder

# Primitives: Silhouette Curves

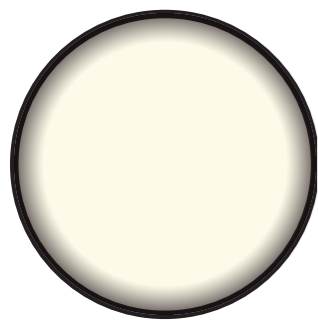

sphere

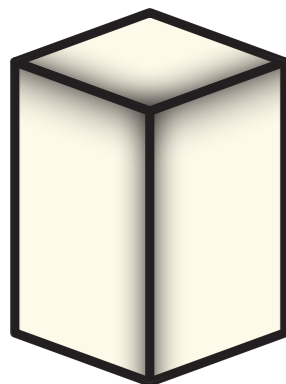

box

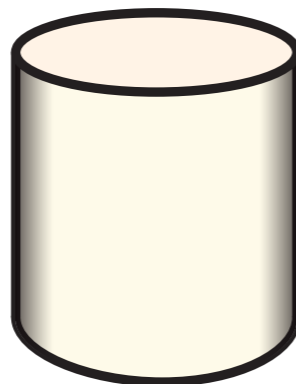

straight  
cylinder

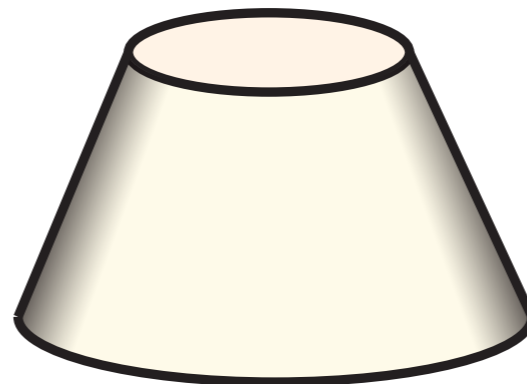

truncated cone

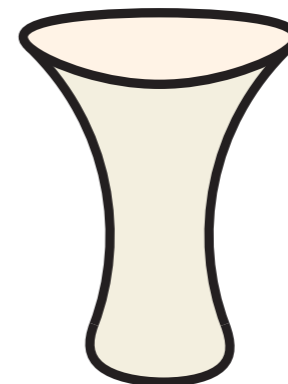

straight  
generalized  
cylinder

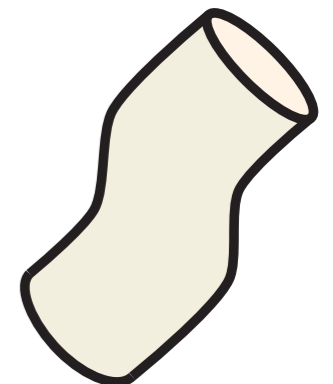

bent  
generalized  
cylinder

# Primitives: Silhouette Curves

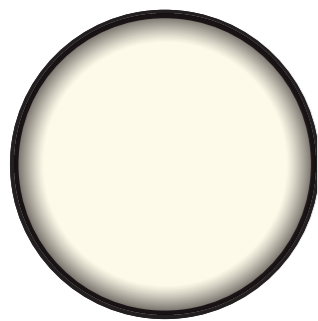

sphere

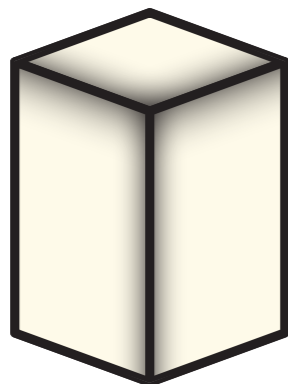

box

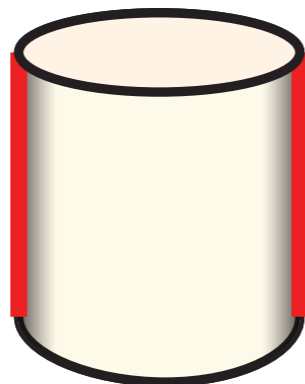

straight  
cylinder

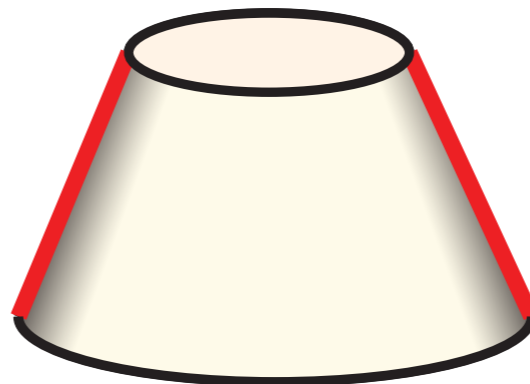

truncated cone

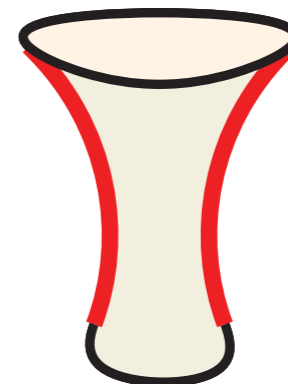

straight  
generalized  
cylinder

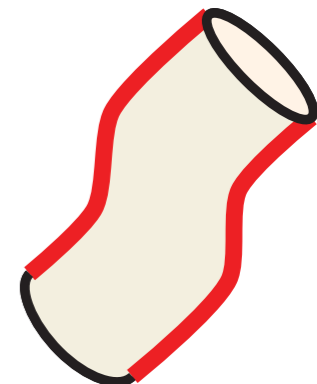

bent  
generalized  
cylinder

# Tagging

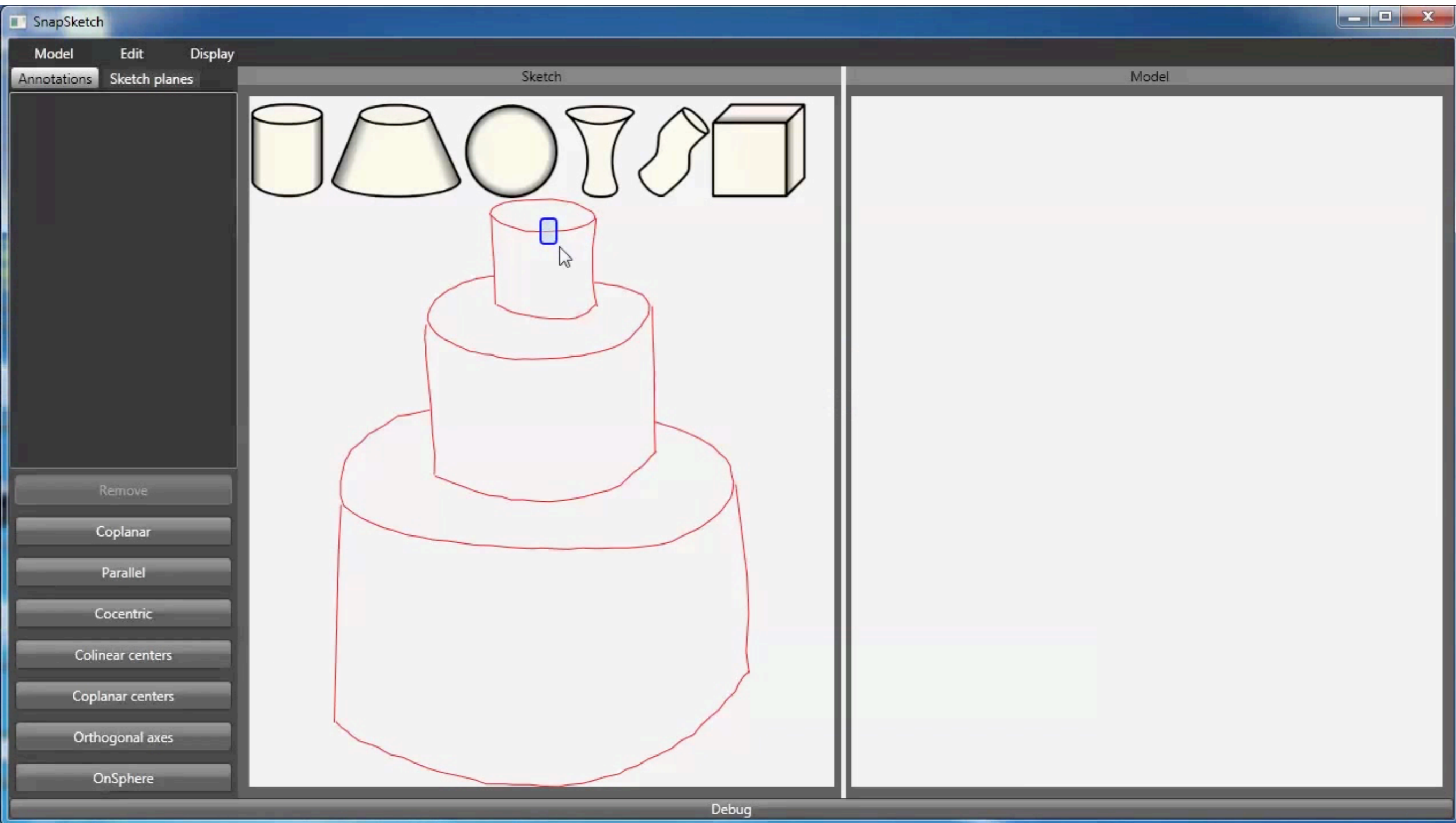

# Tagging

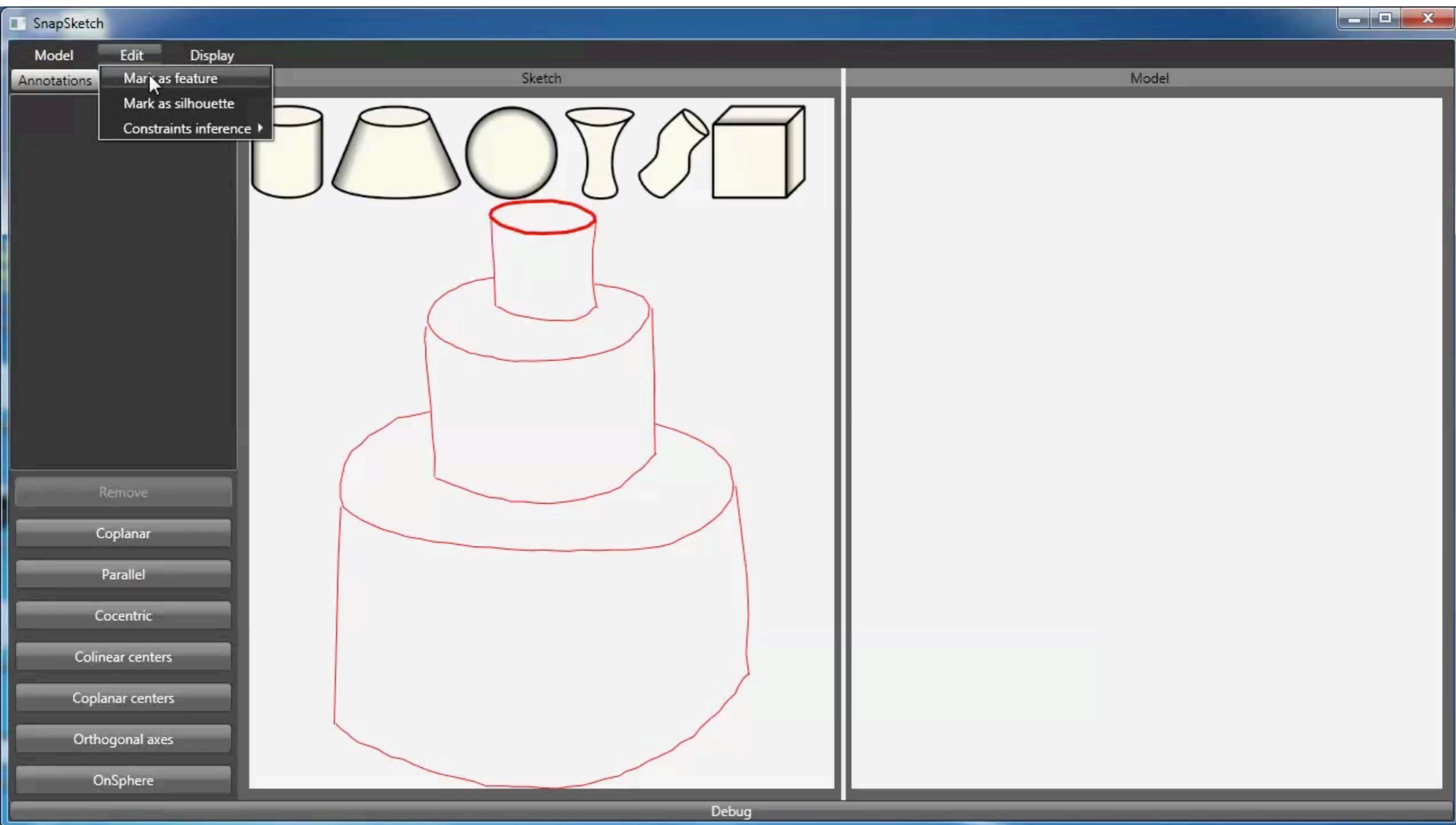

# Tagging

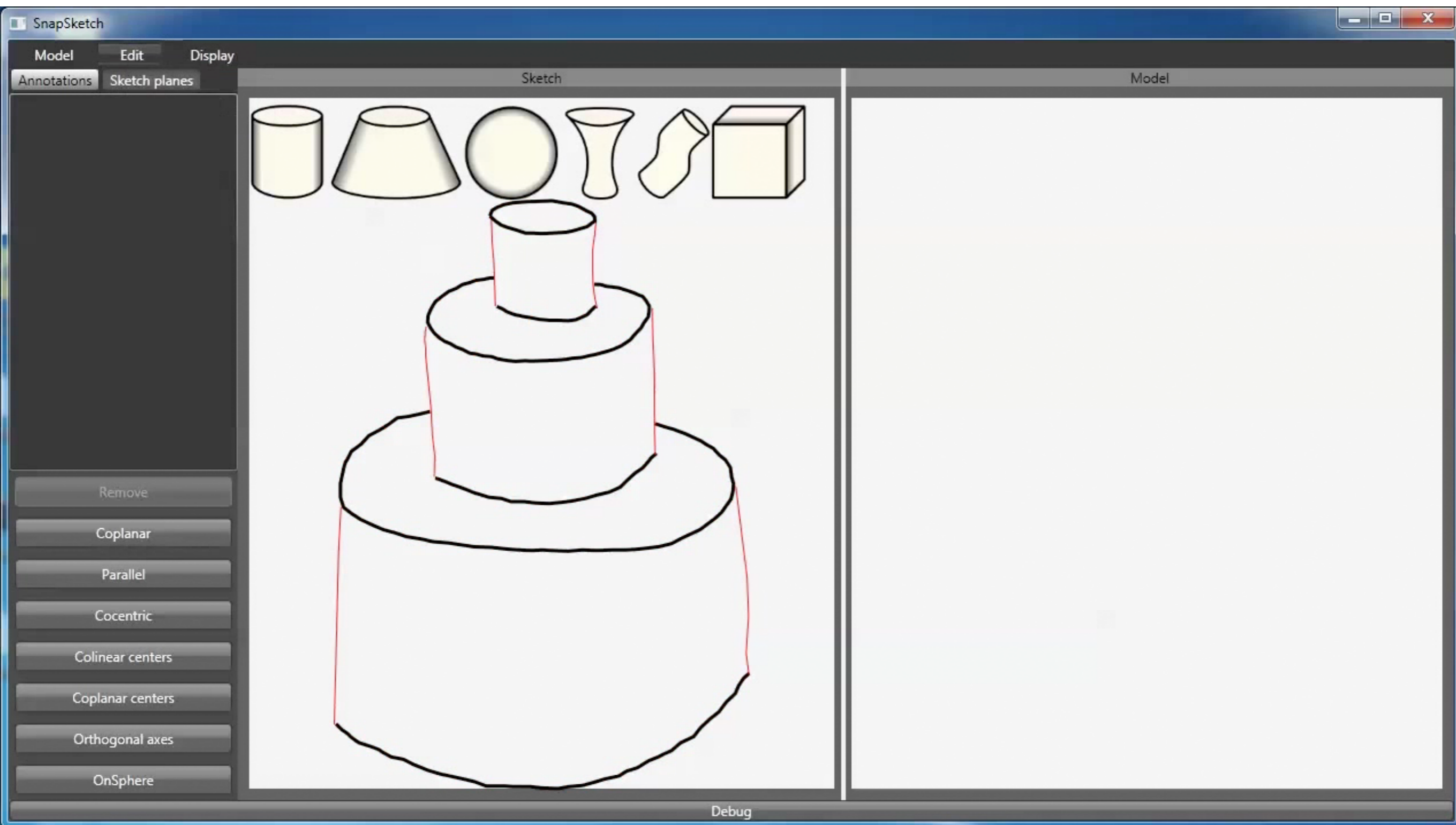

# Drag-and-Drop

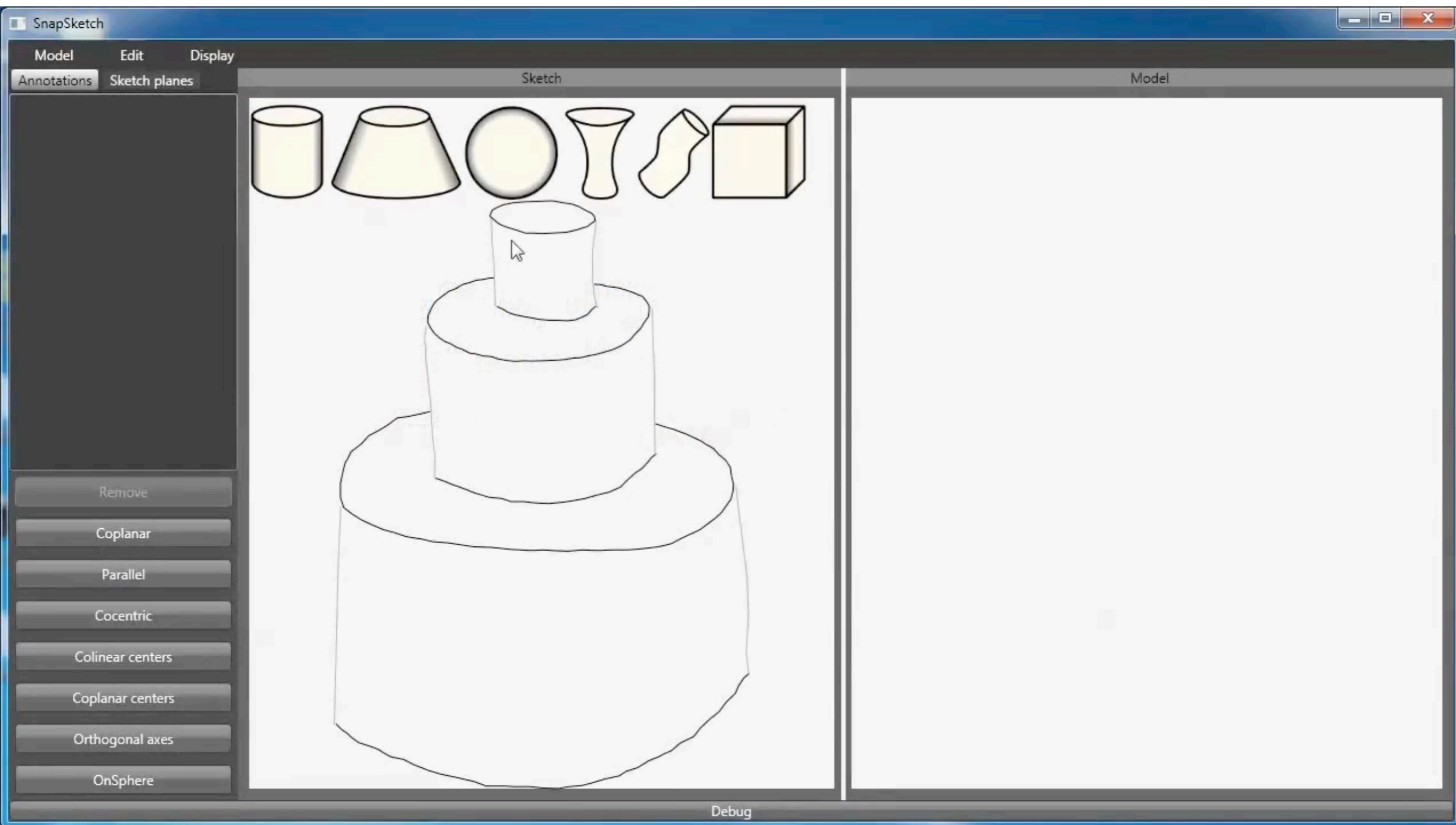



# Anatomy of a Drag: Curve Matching

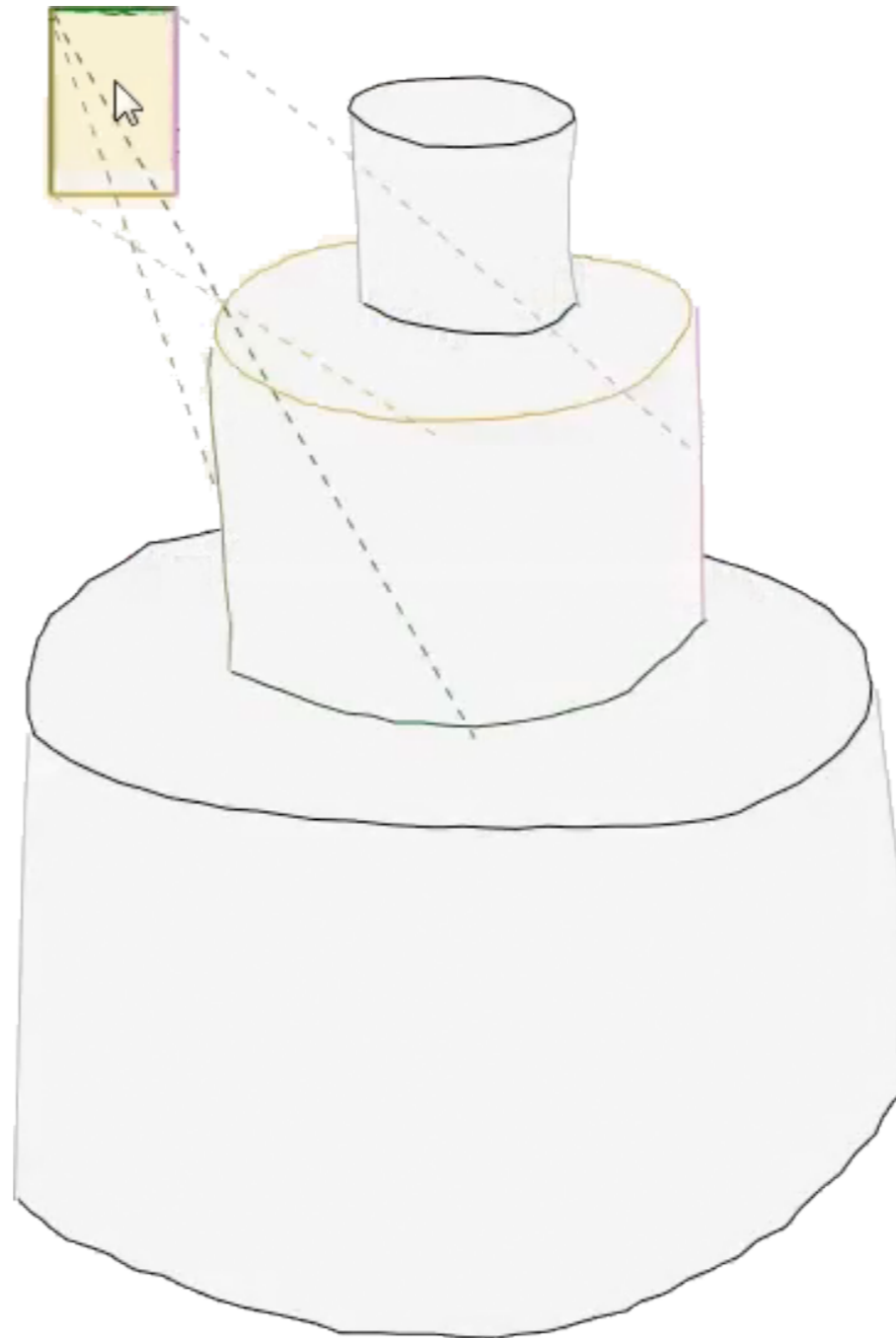

# Anatomy of a Drag: Curve Matching

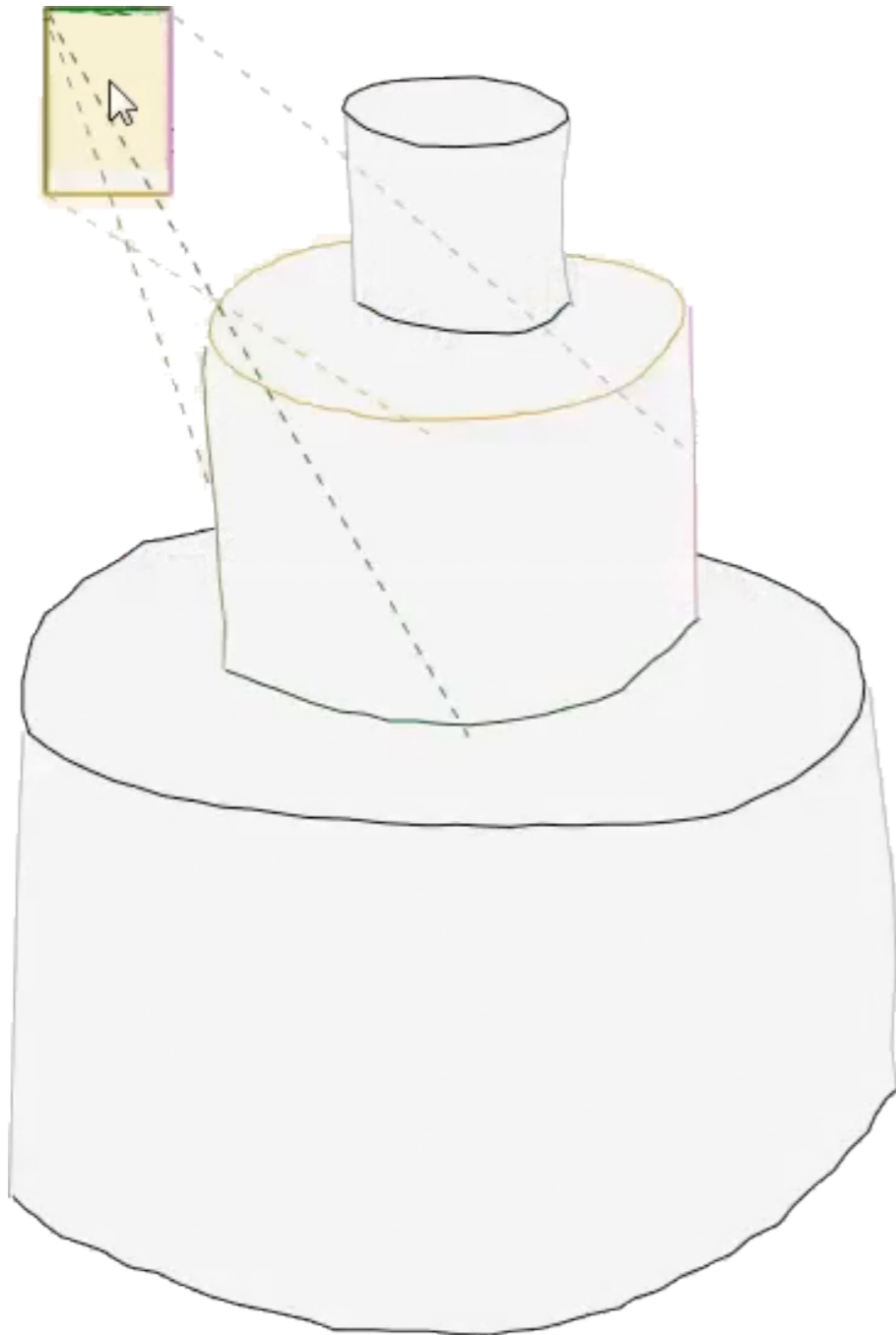

# Anatomy of a Drag: Curve Matching

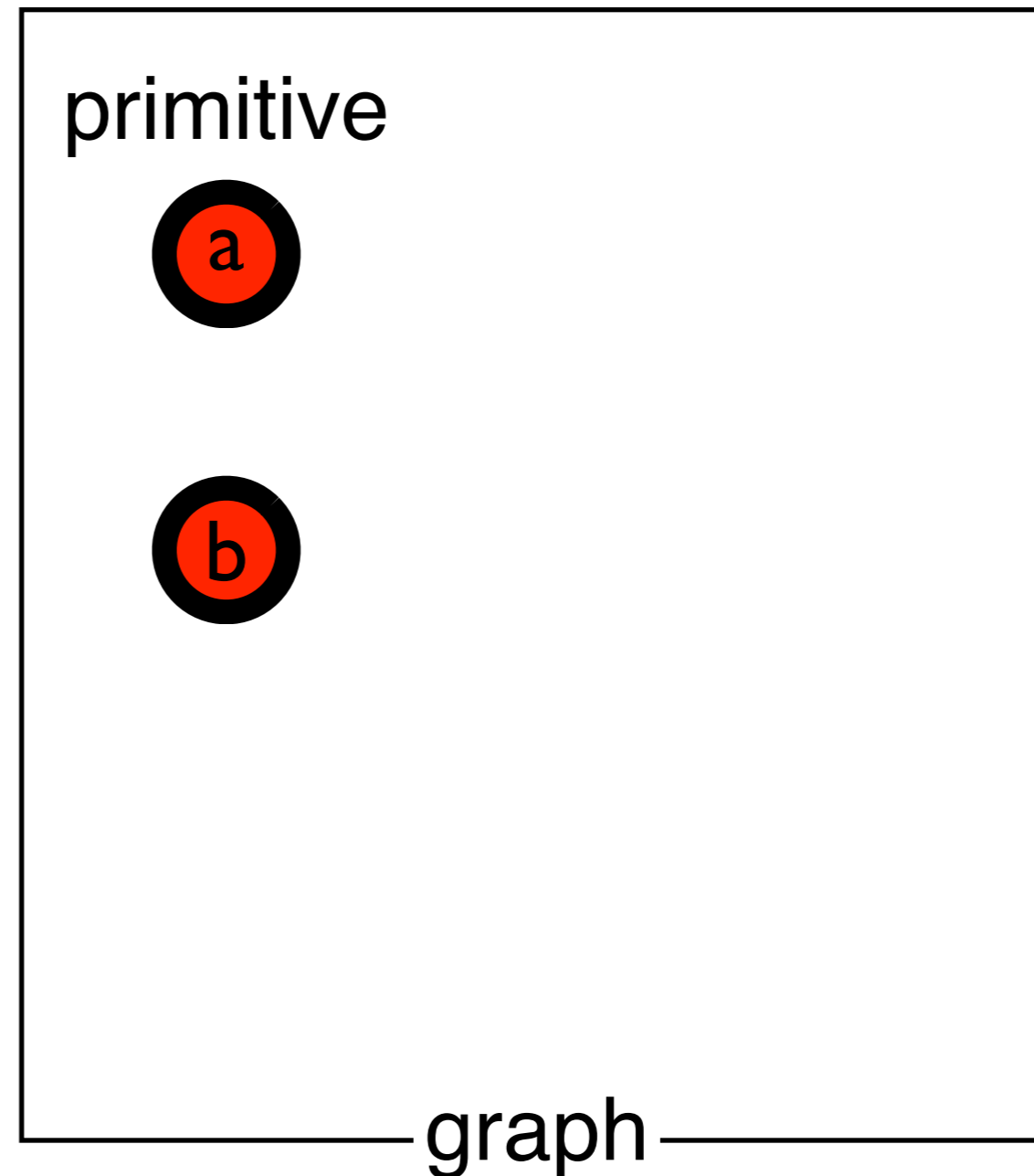
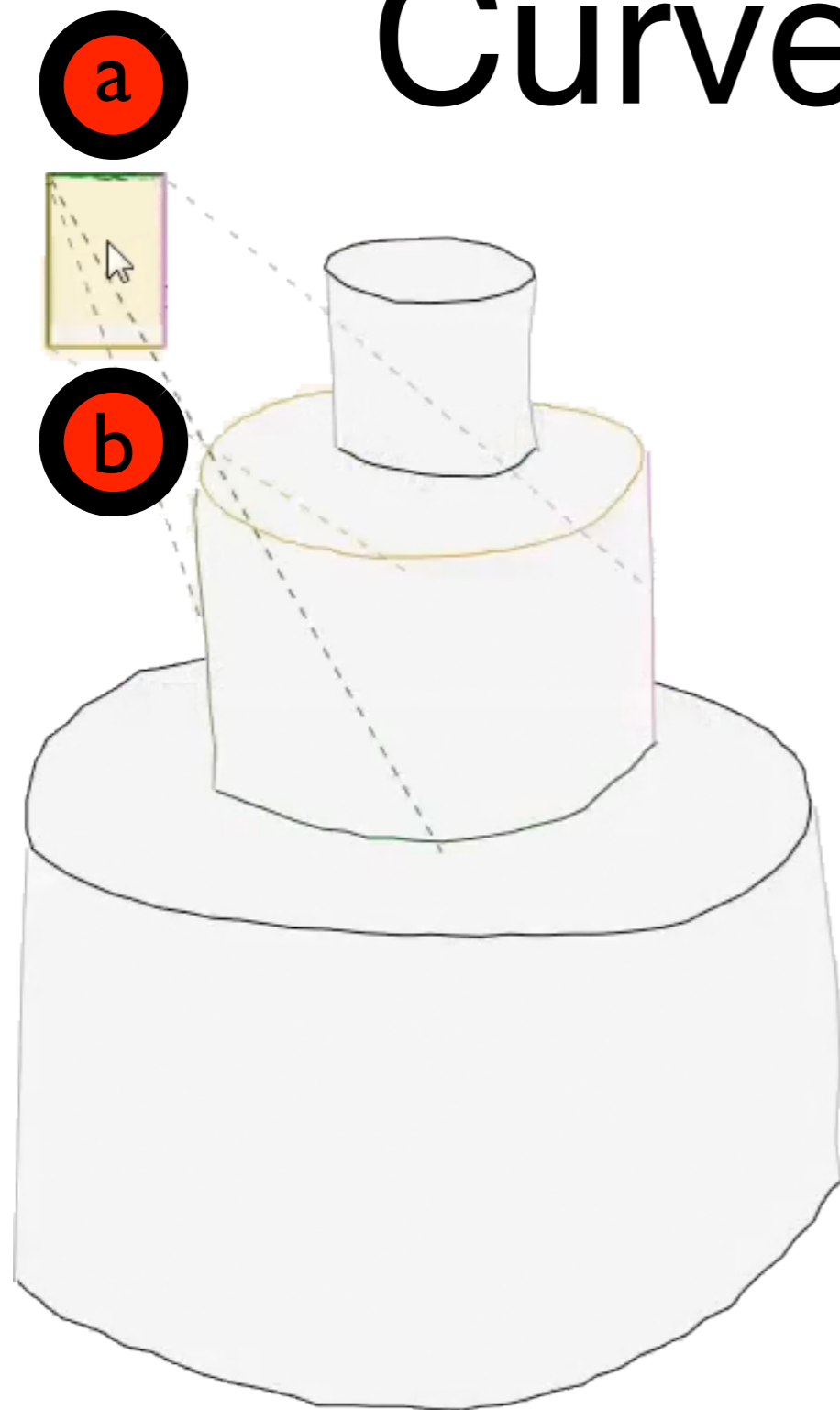

# Anatomy of a Drag: Curve Matching

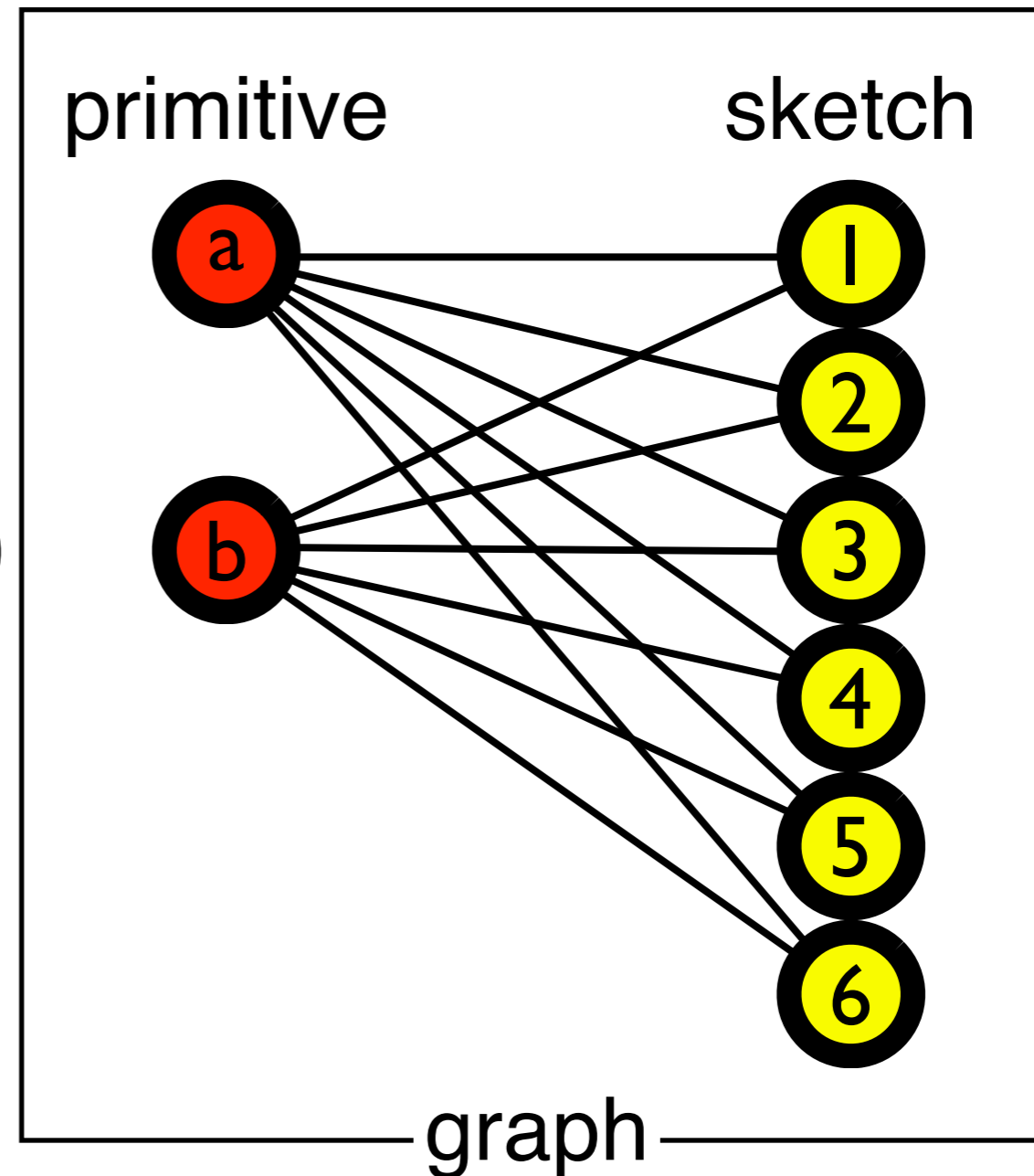
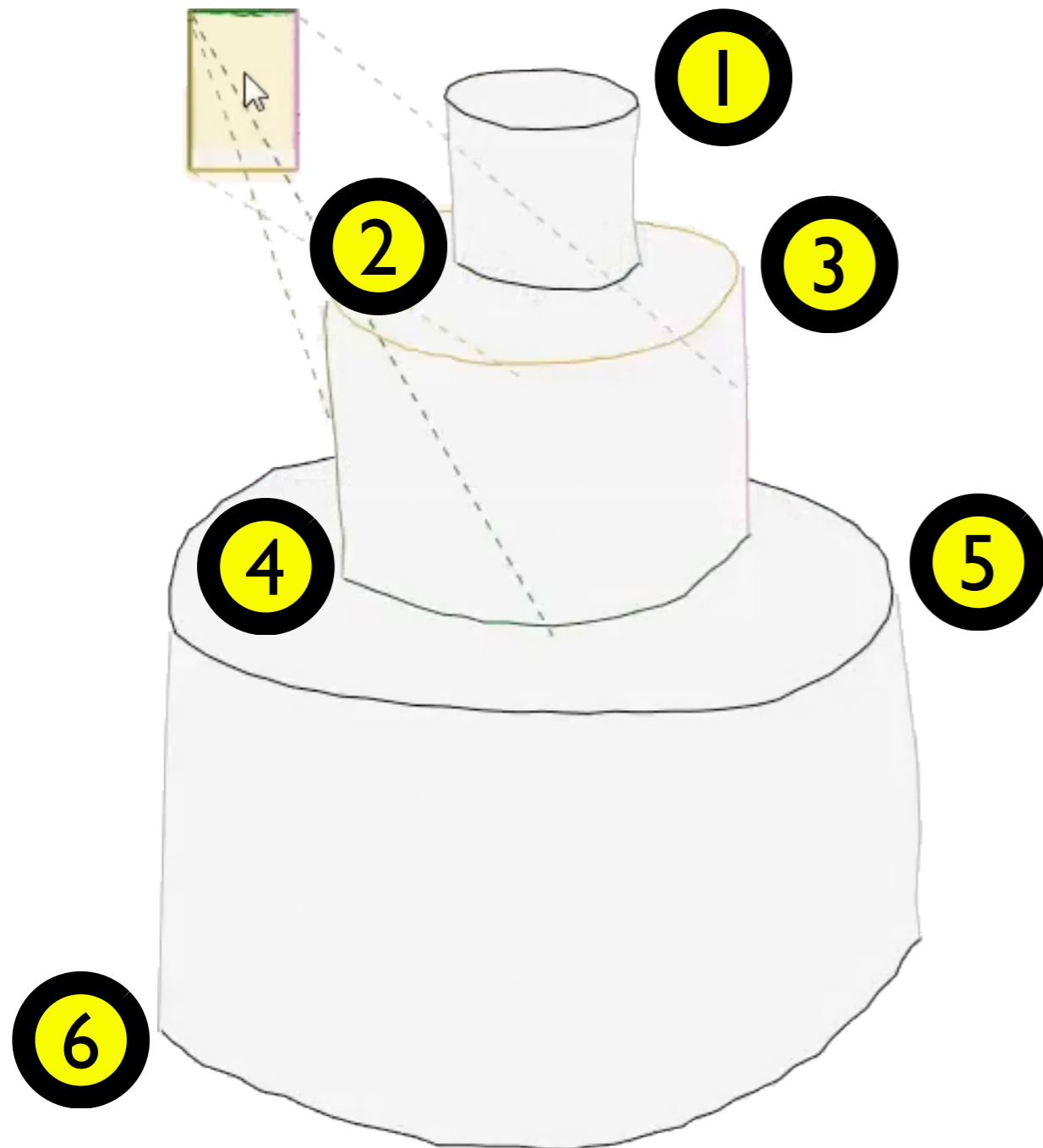

# Anatomy of a Drag: Curve Matching

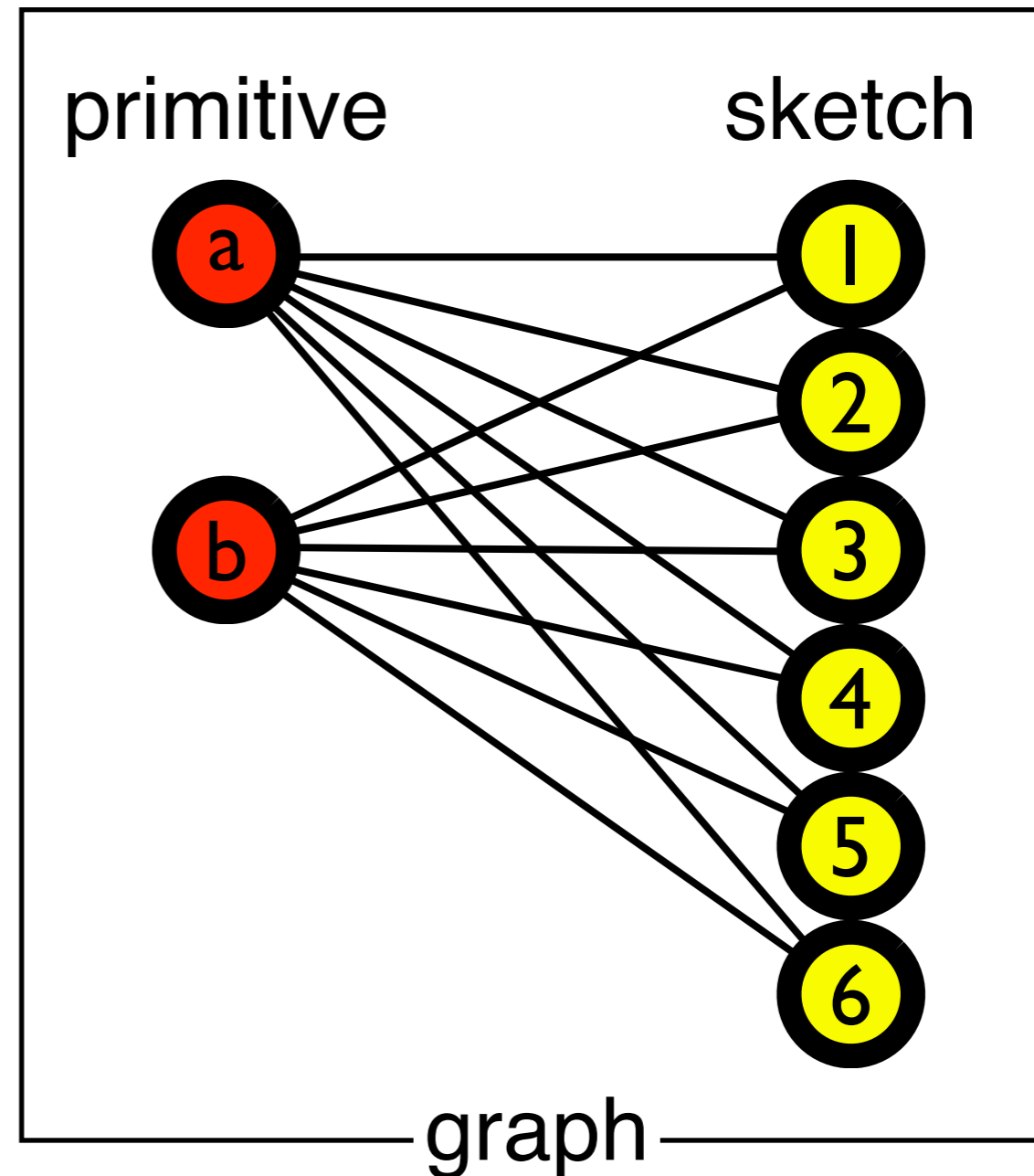
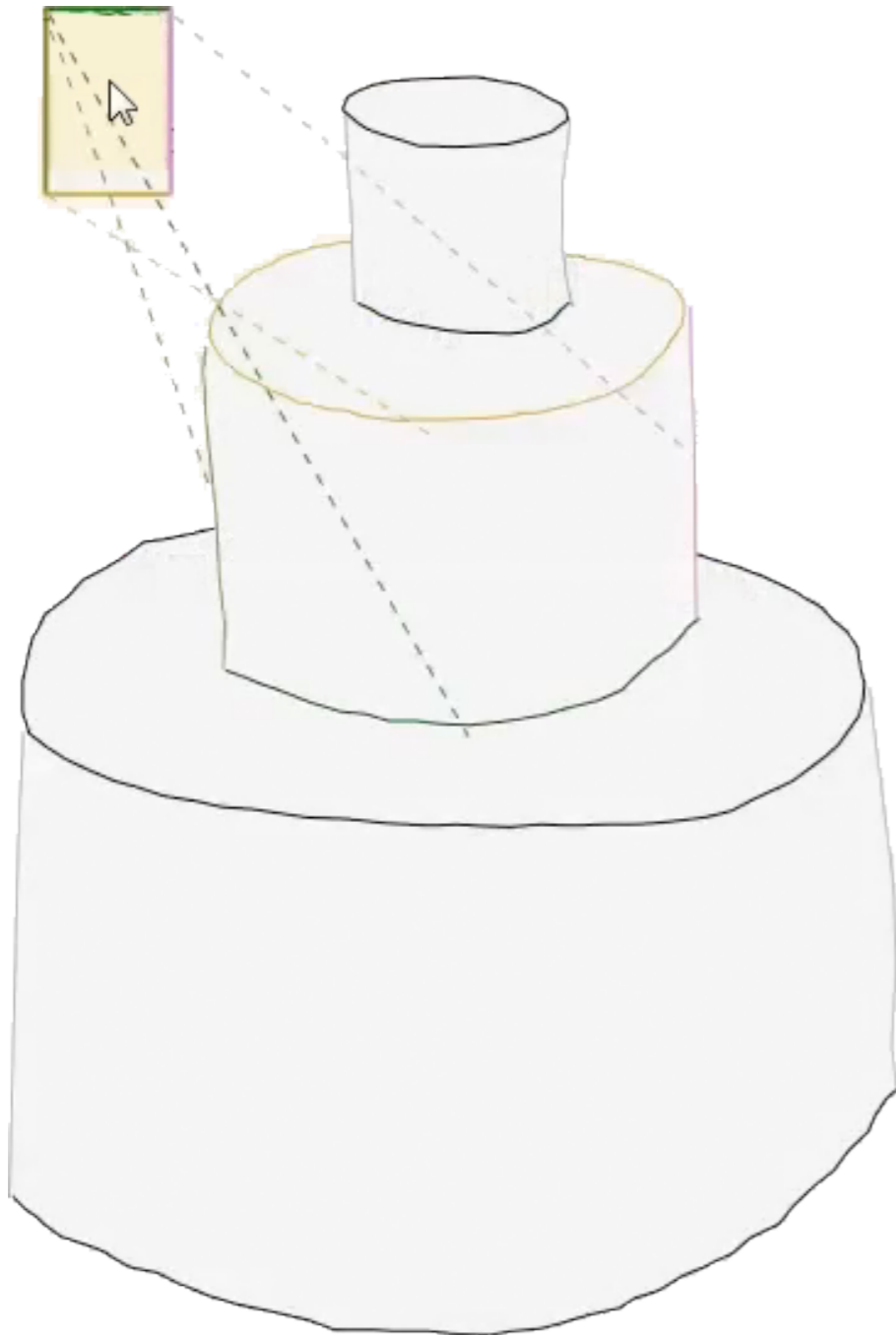

# Anatomy of a Drag: Curve Matching

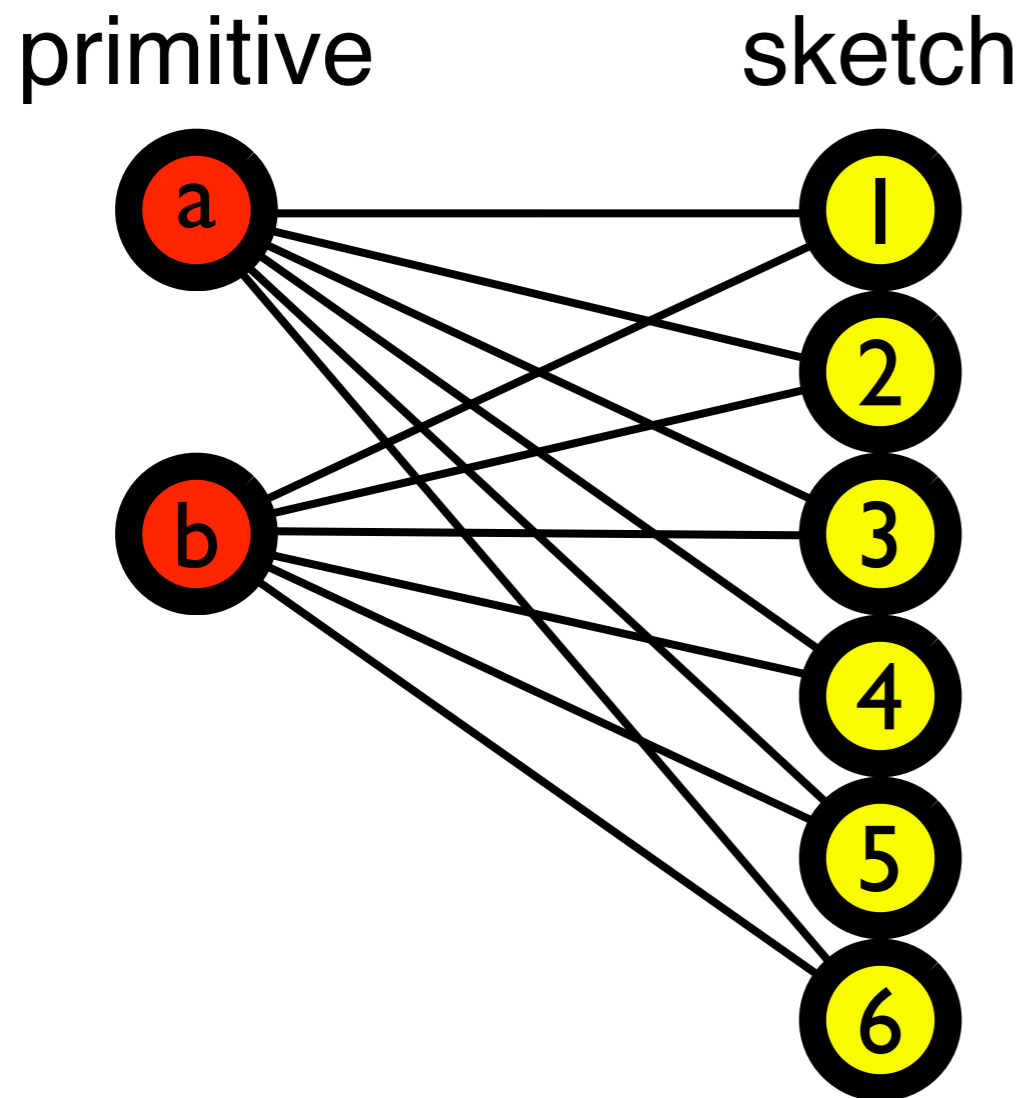

# Anatomy of a Drag: Curve Matching

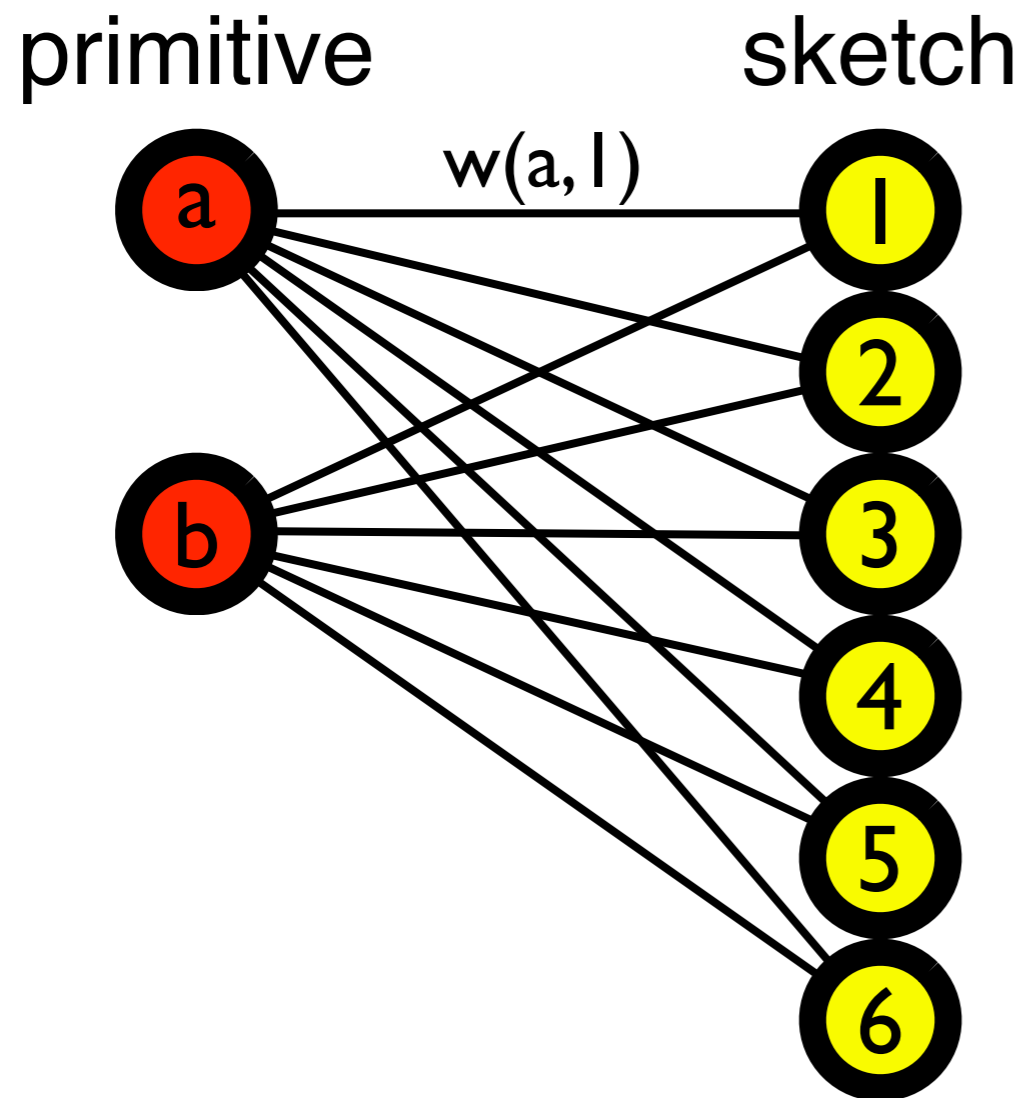

# Anatomy of a Drag: Curve Matching

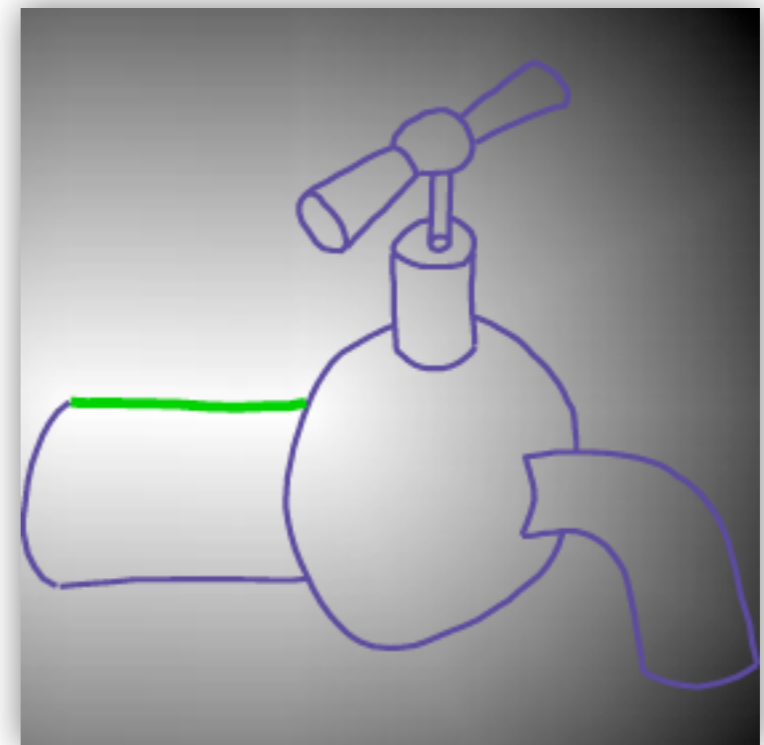
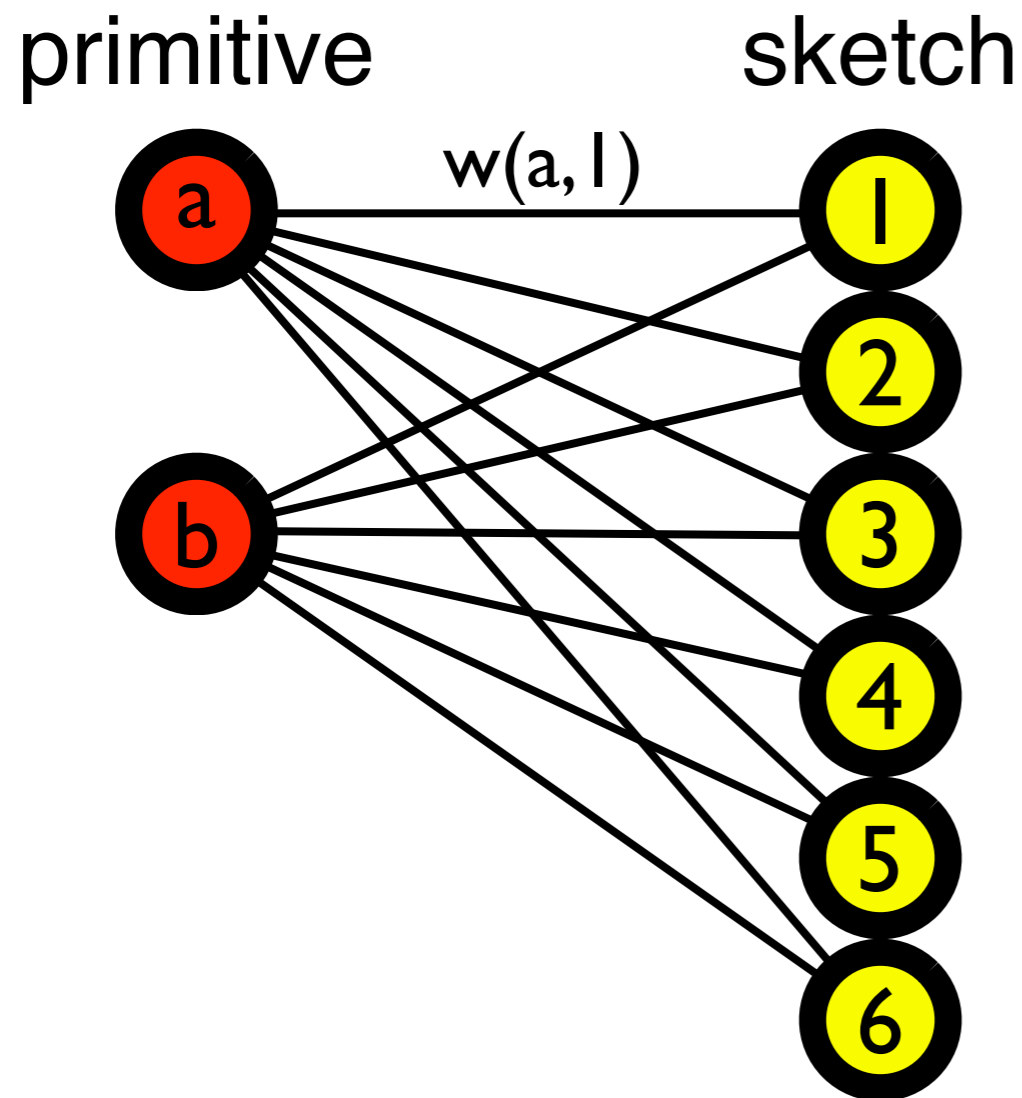



# Anatomy of a Drag: Curve Matching

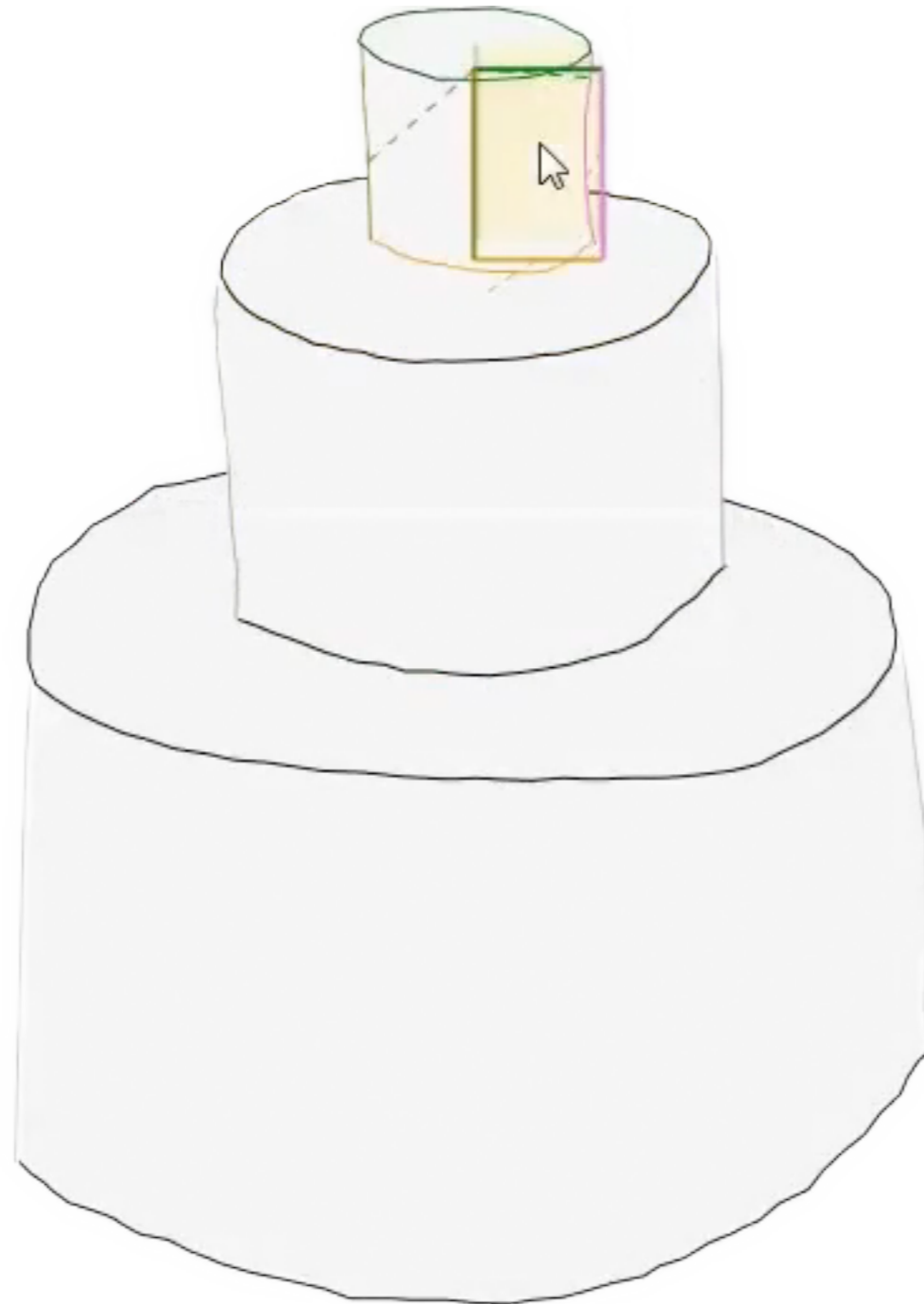

# Anatomy of a Drag: Primitive Fitting

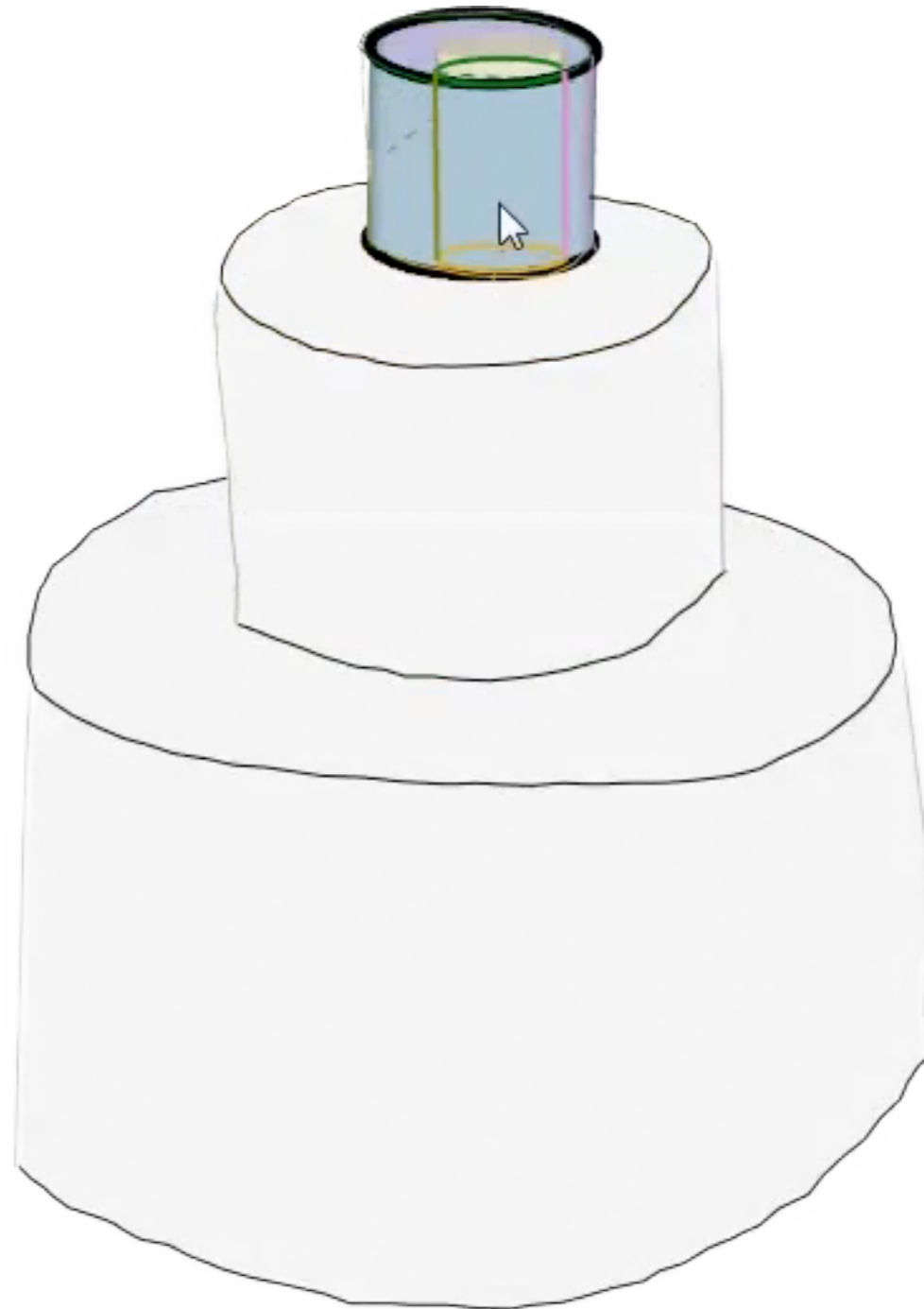

# Anatomy of a Drag: Primitive Fitting

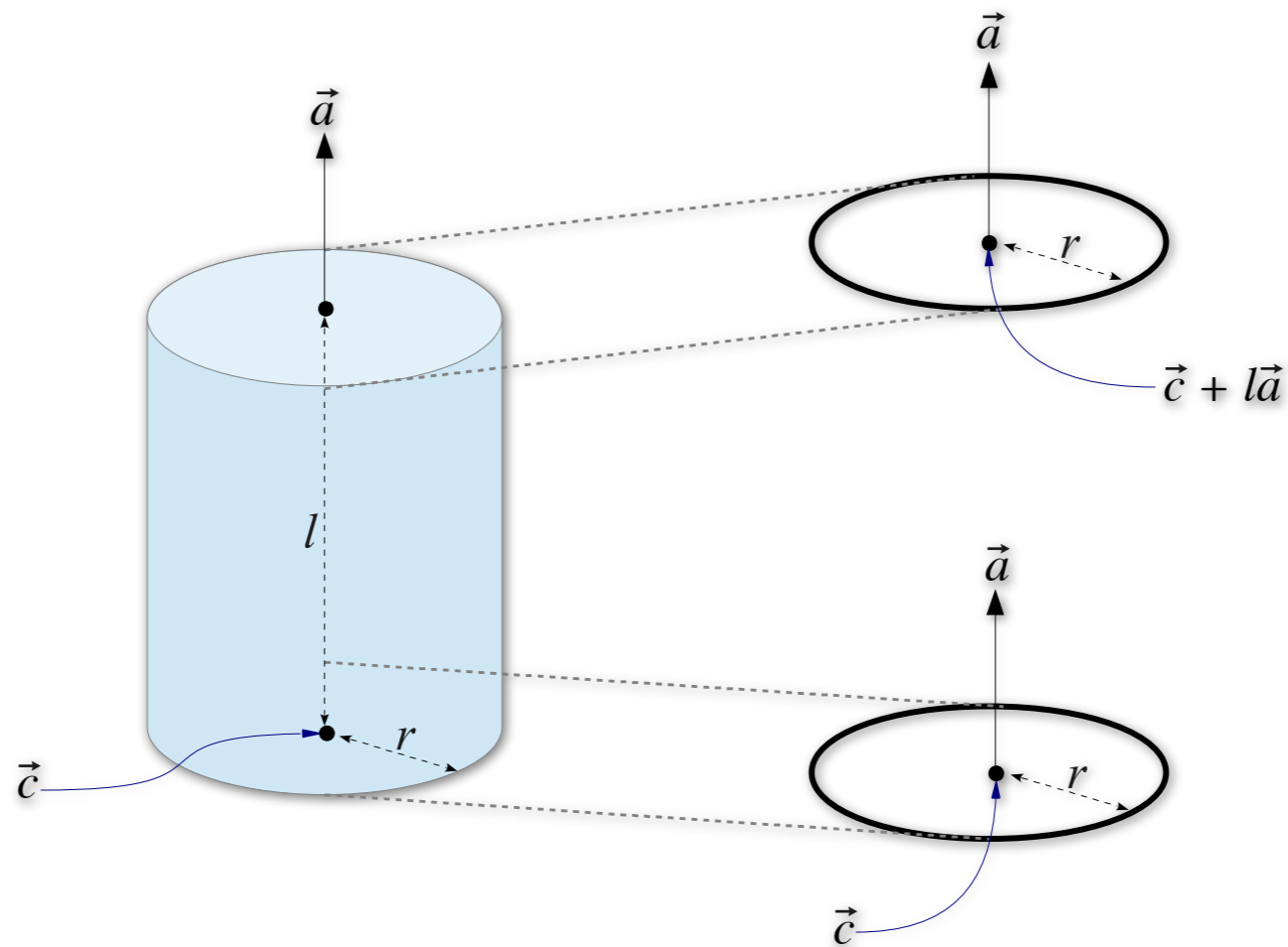

# Anatomy of a Drag: Primitive Fitting

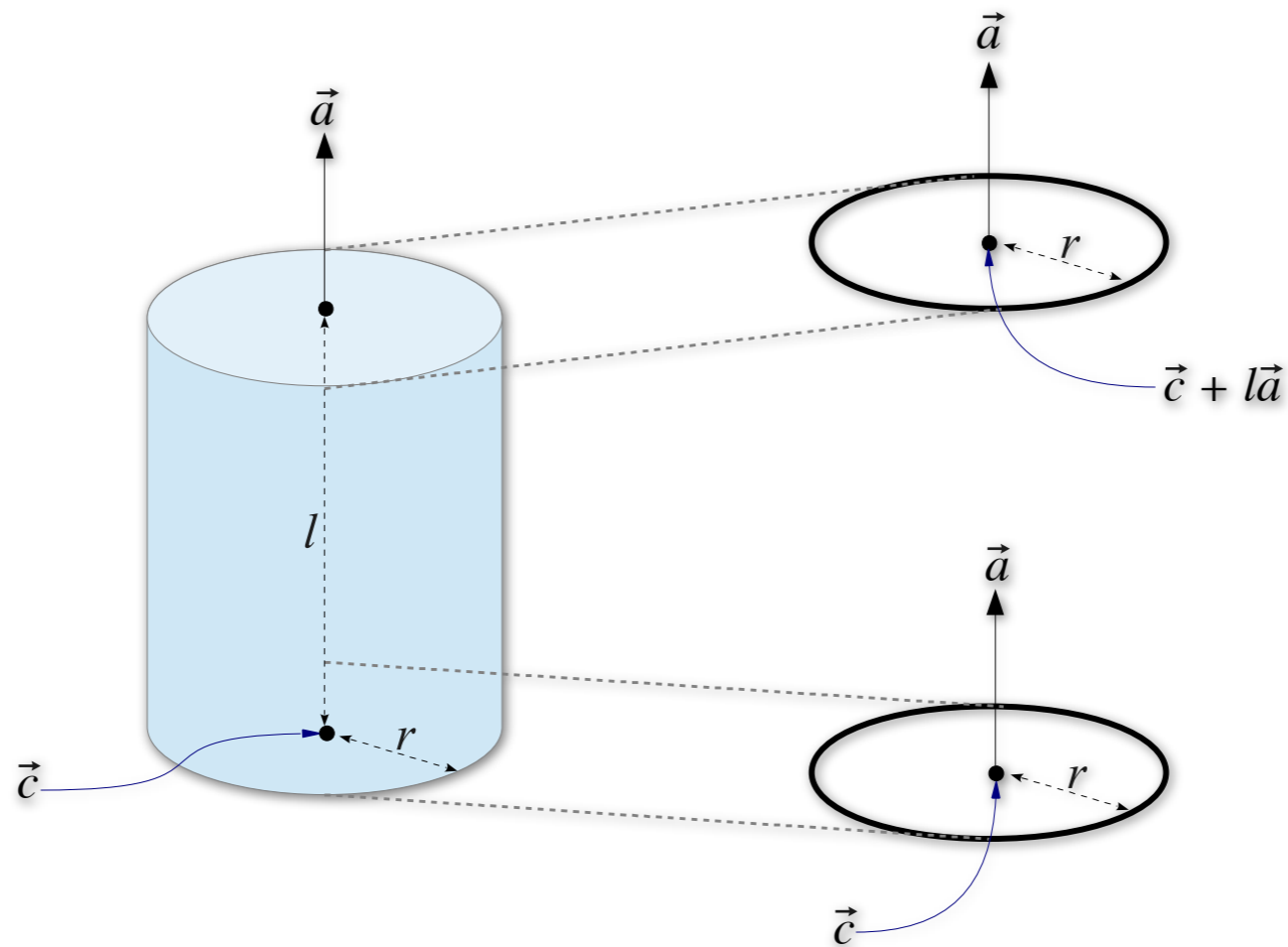

$$\begin{aligned} \min : & \phi_p(x_p) \\ \text{s.t.} : & C_p(x_p) = 0 \end{aligned}$$

# Anatomy of a Drag: Primitive Fitting

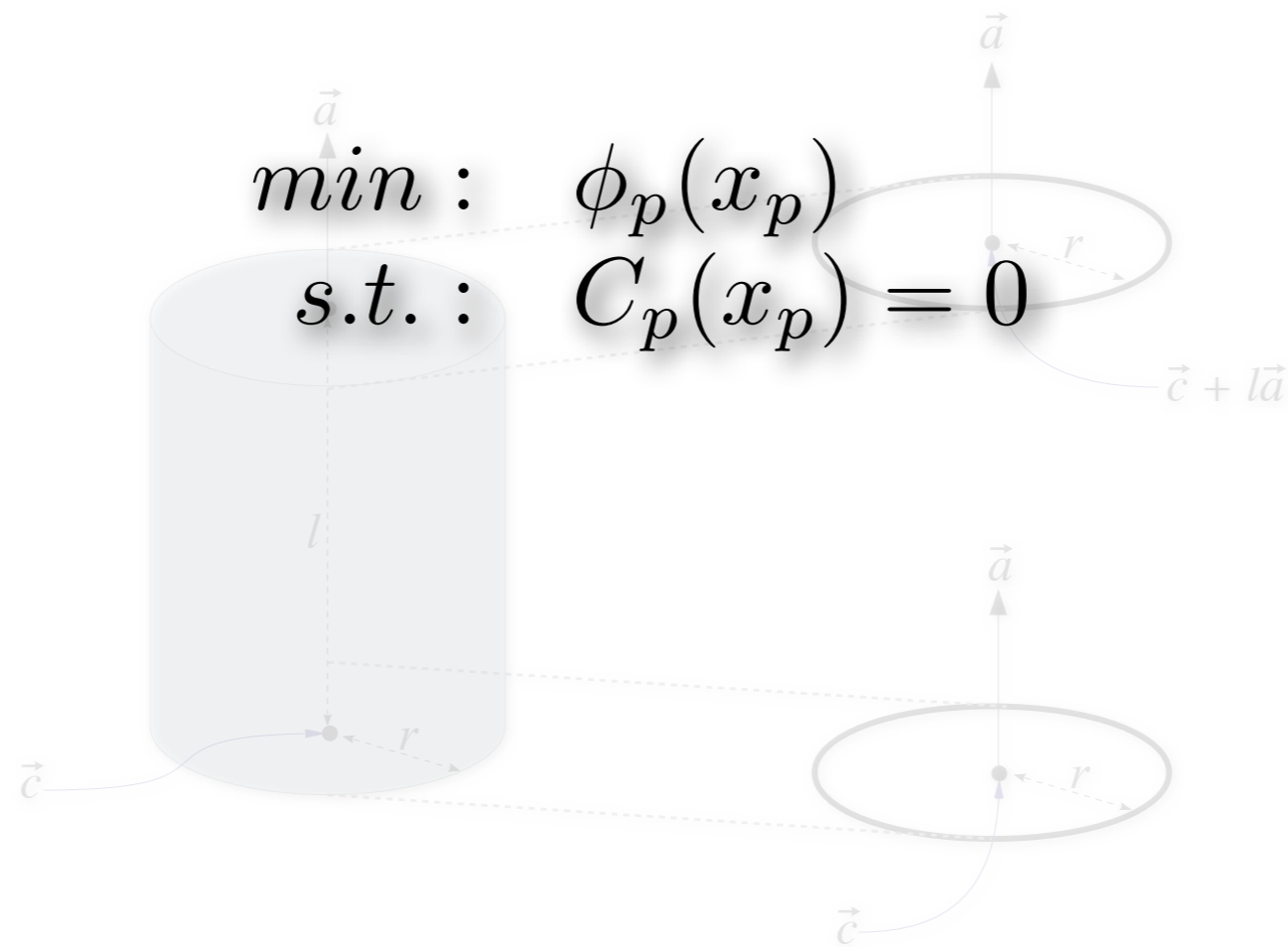

# Anatomy of a Drag: Primitive Fitting

$$\begin{aligned} \min : & \phi_p(x_p) \\ \text{s.t.} : & C_p(x_p) = 0 \end{aligned}$$

$$L_{drag}(x; \mu, \lambda) = f(x) + \underbrace{\sum_{i=1}^m \lambda_i \cdot c_i(x)}_{\text{Lagrangian term}} + \underbrace{\frac{\mu}{2} \cdot \sum_{i=1}^m |c_i(x)|^2}_{\text{Penalty term}}$$

# Anatomy of a Drag: Primitive Fitting

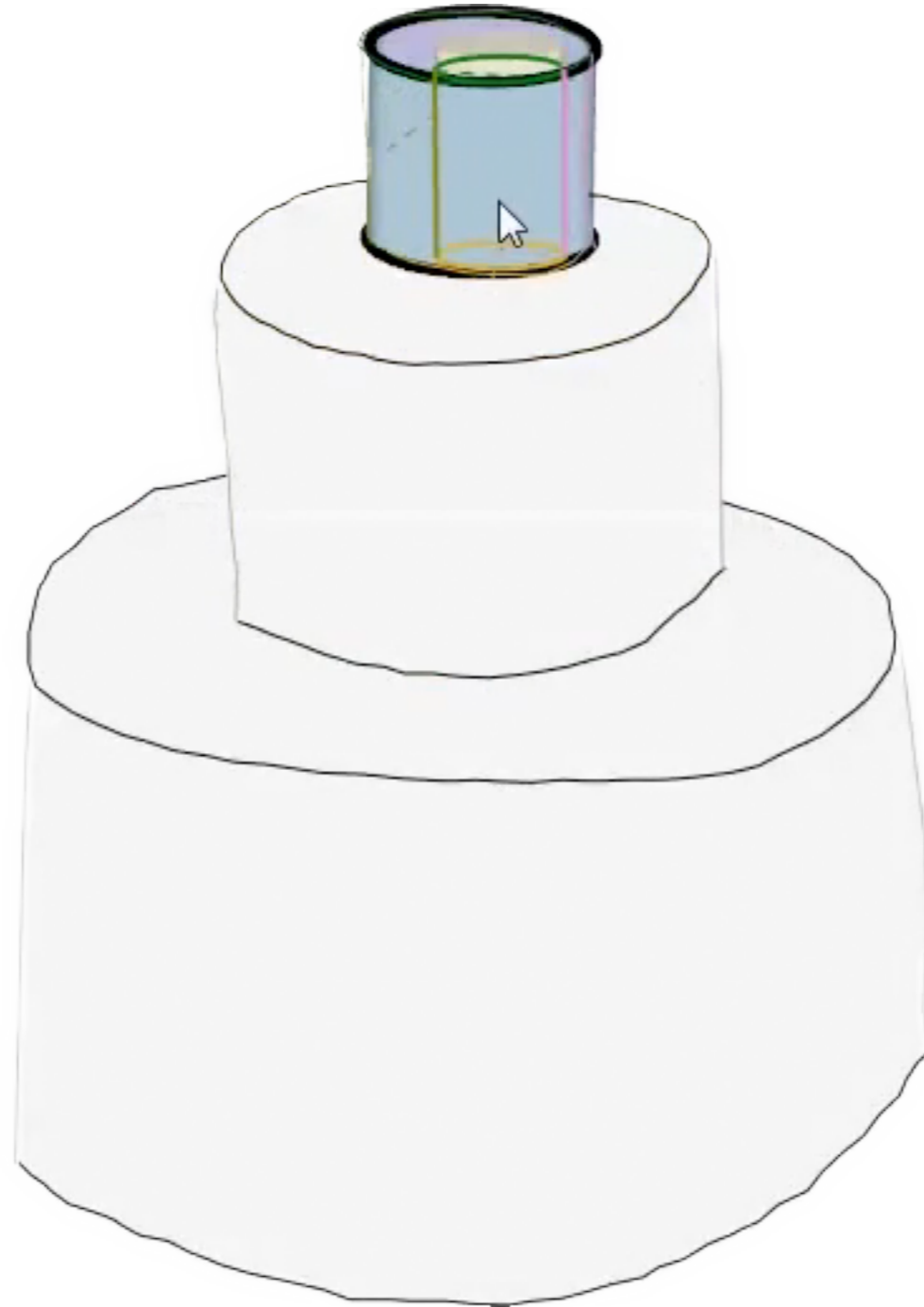

# Anatomy of a Drag: Geosemantic Relations

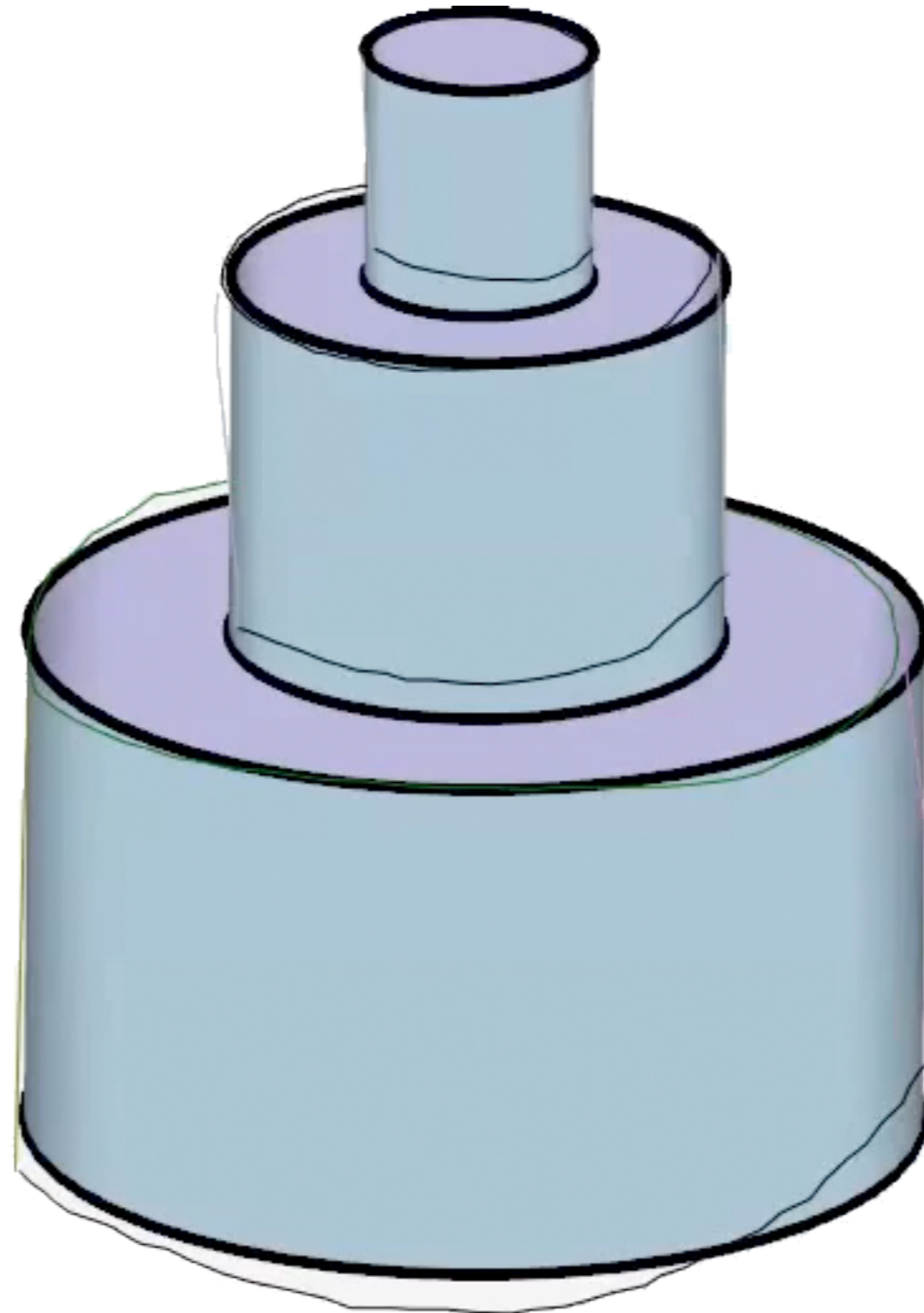



# Anatomy of a Drag: Geosemantic Relations

$$\begin{aligned} \min_x : & \quad \sum_{p \in P} \phi_p(x_p) \\ \text{s.t.} : & \quad C_p(x_p) = 0 \quad \forall p \in P \\ & \quad \psi_g(x_g) = 0 \quad \forall g \in G \end{aligned}$$

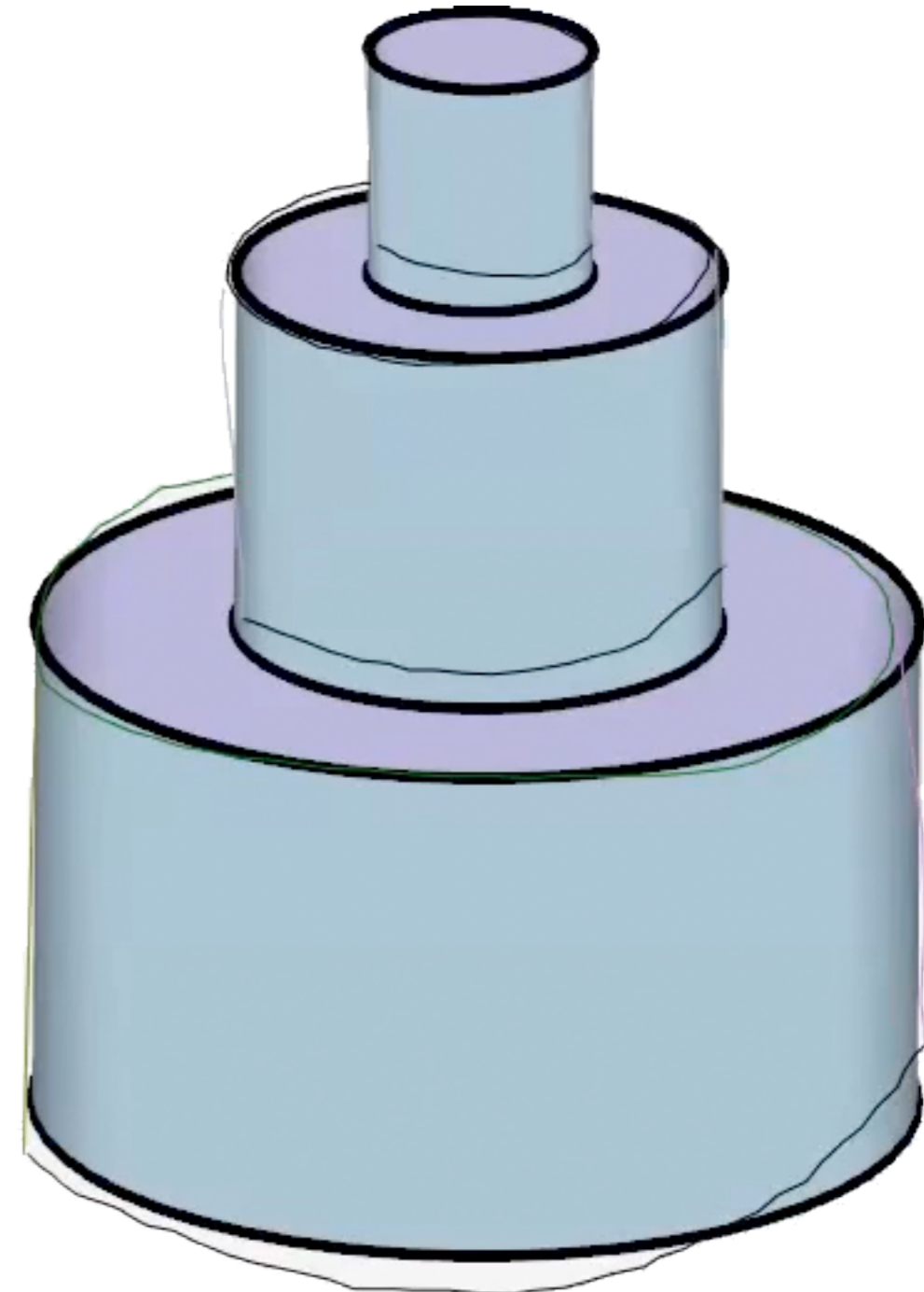

# Geosemantic Relations

Constraints linking two or more feature curves:

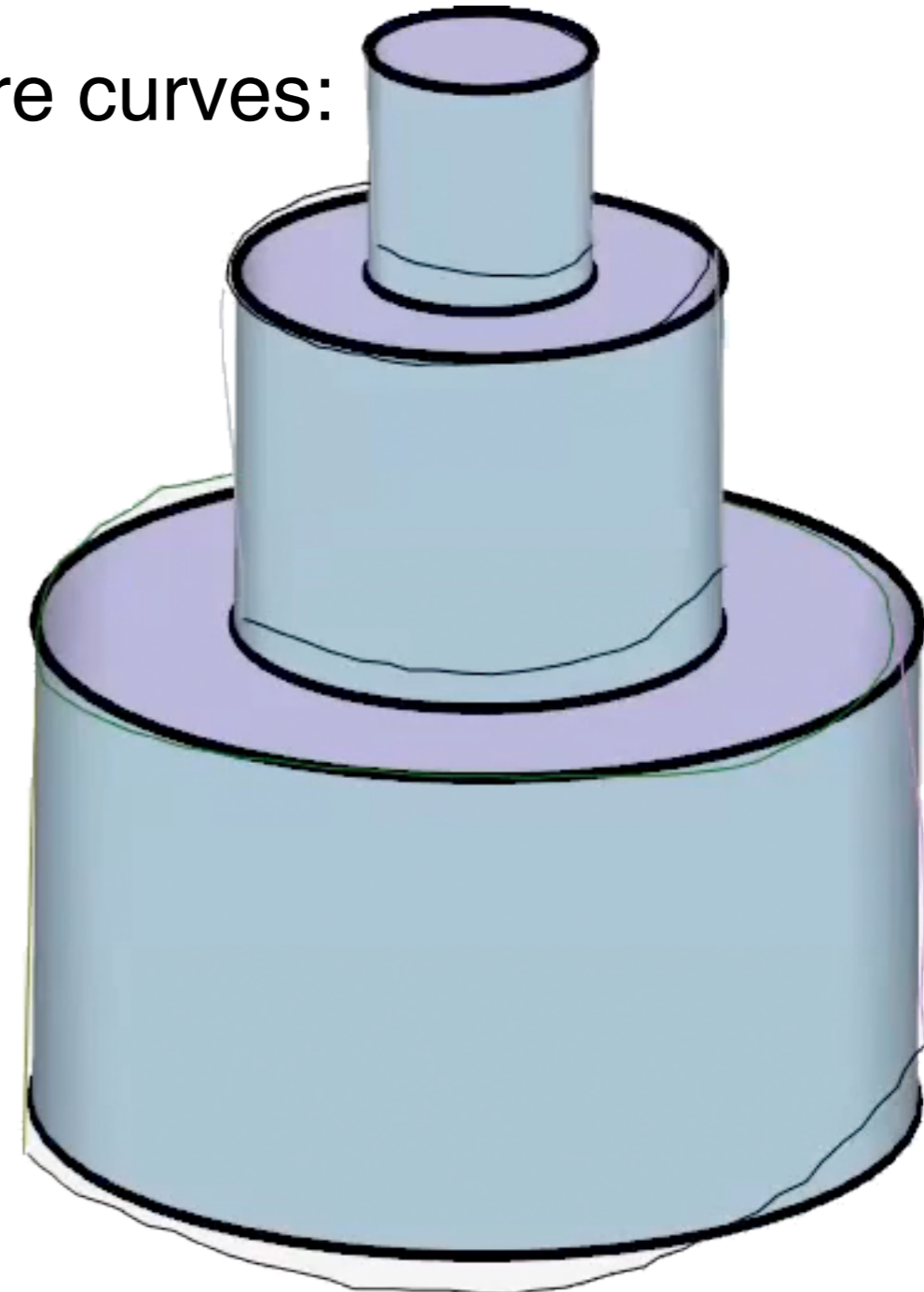

# Geosemantic Relations

Constraints linking two or more feature curves:

- Parallelism

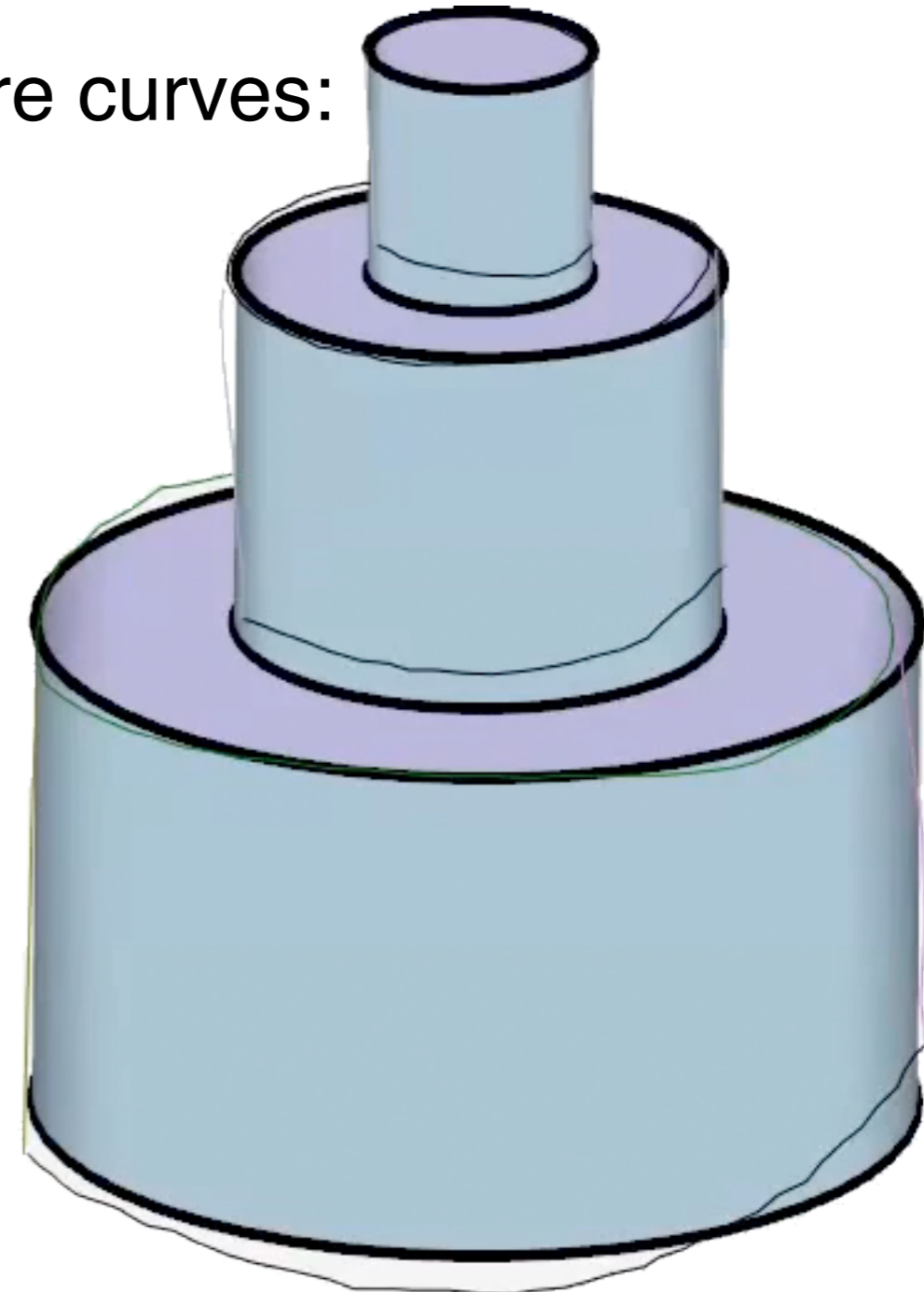

# Geosemantic Relations

Constraints linking two or more feature curves:

- Parallelism
- Orthogonality

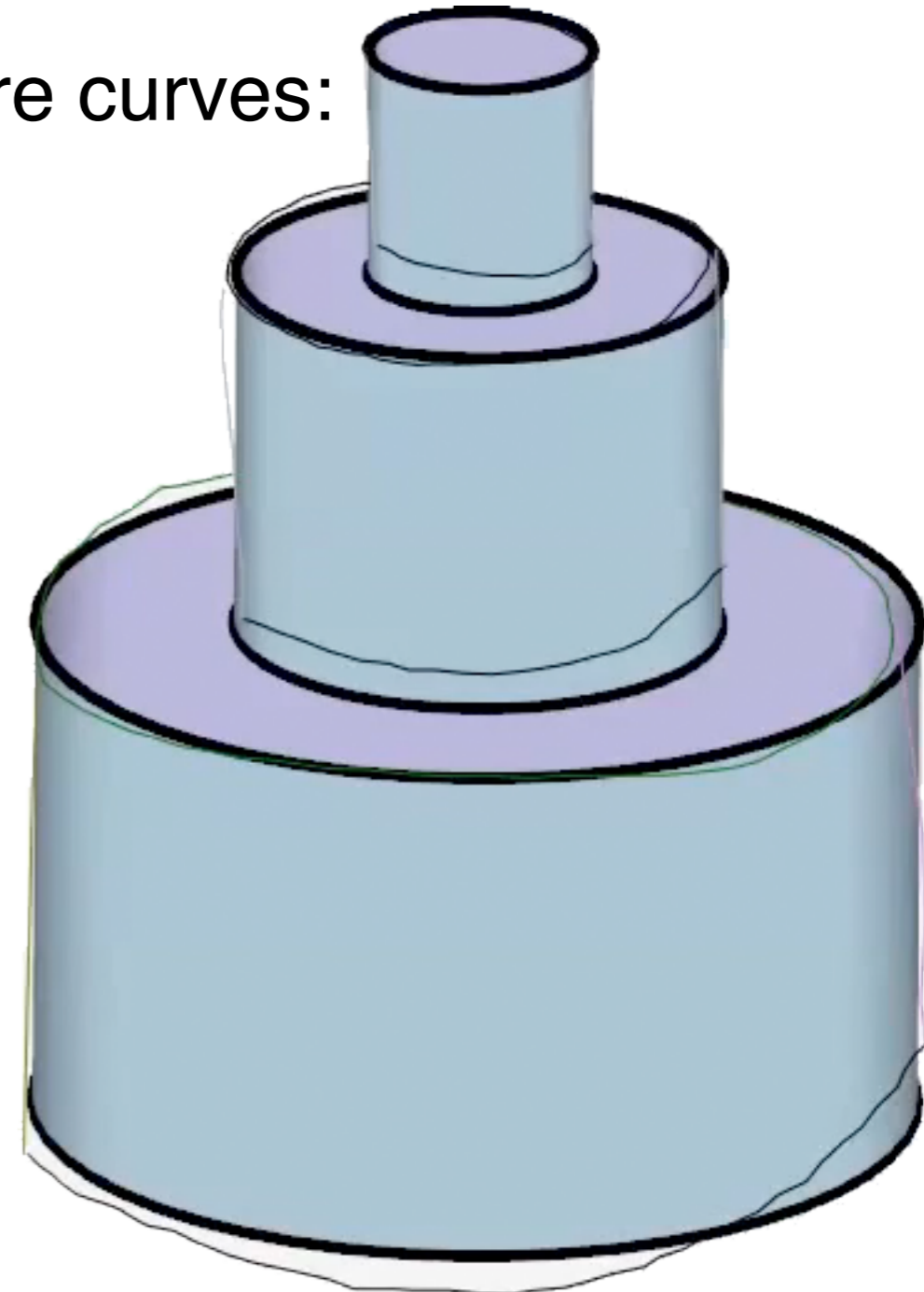

# Geosemantic Relations

Constraints linking two or more feature curves:

- Parallelism
- Orthogonality
- Collinear centers (three or more)

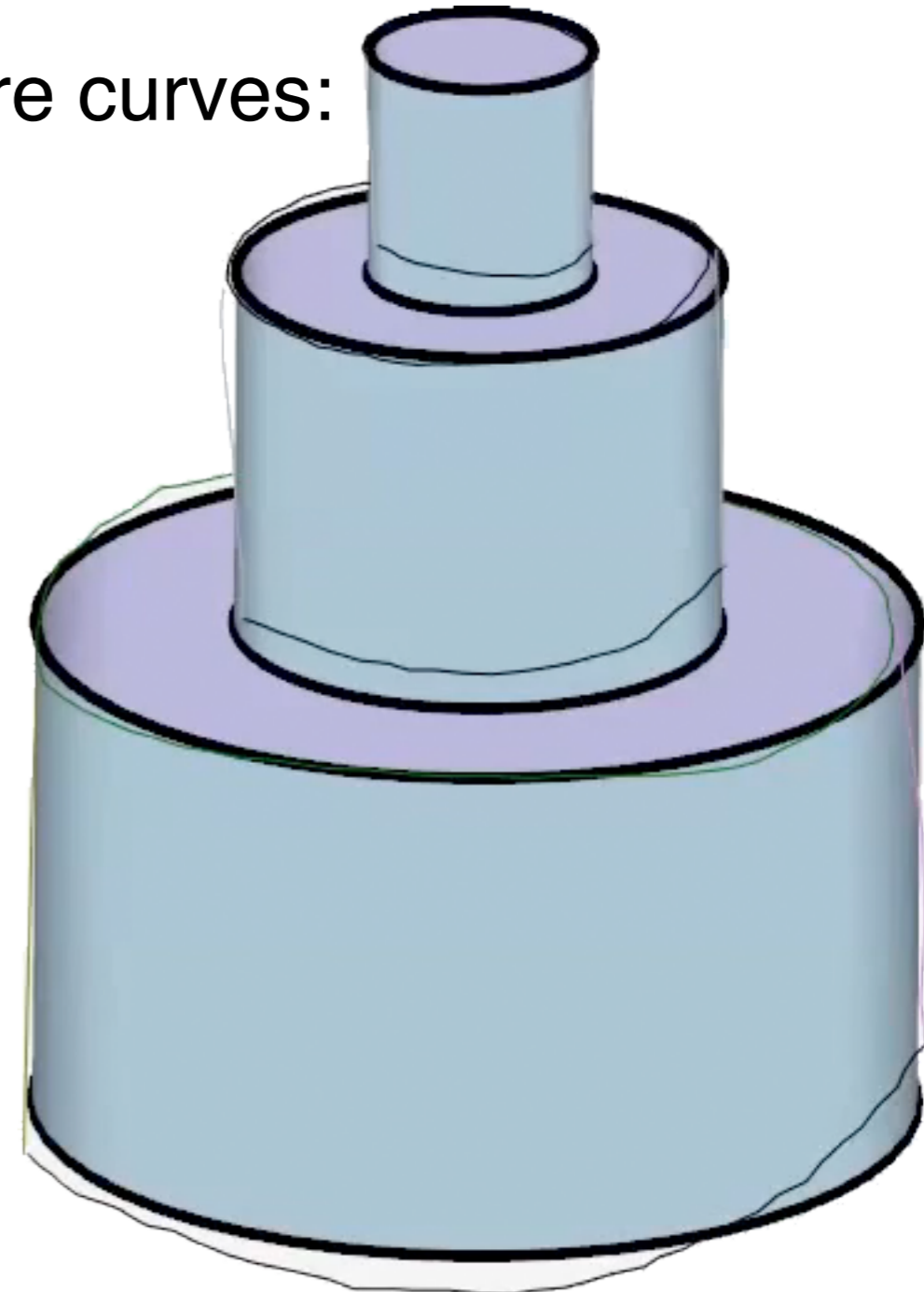

# Geosemantic Relations

Constraints linking two or more feature curves:

- Parallelism
- Orthogonality
- Collinear centers (three or more)
- Concentric

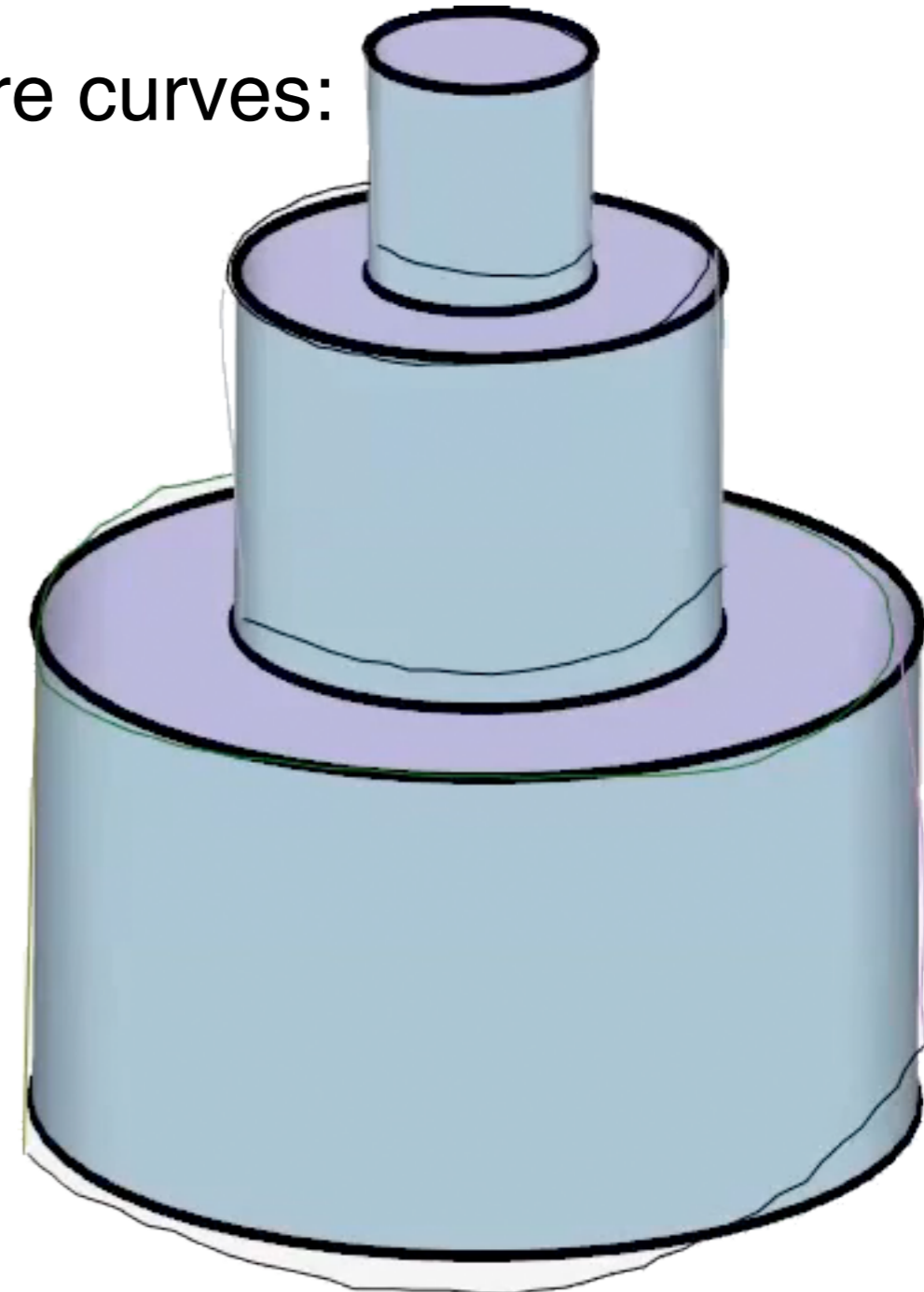

# Geosemantic Relations

Constraints linking two or more feature curves:

- Parallelism
- Orthogonality
- Collinear centers (three or more)
- Concentric
- Coplanar

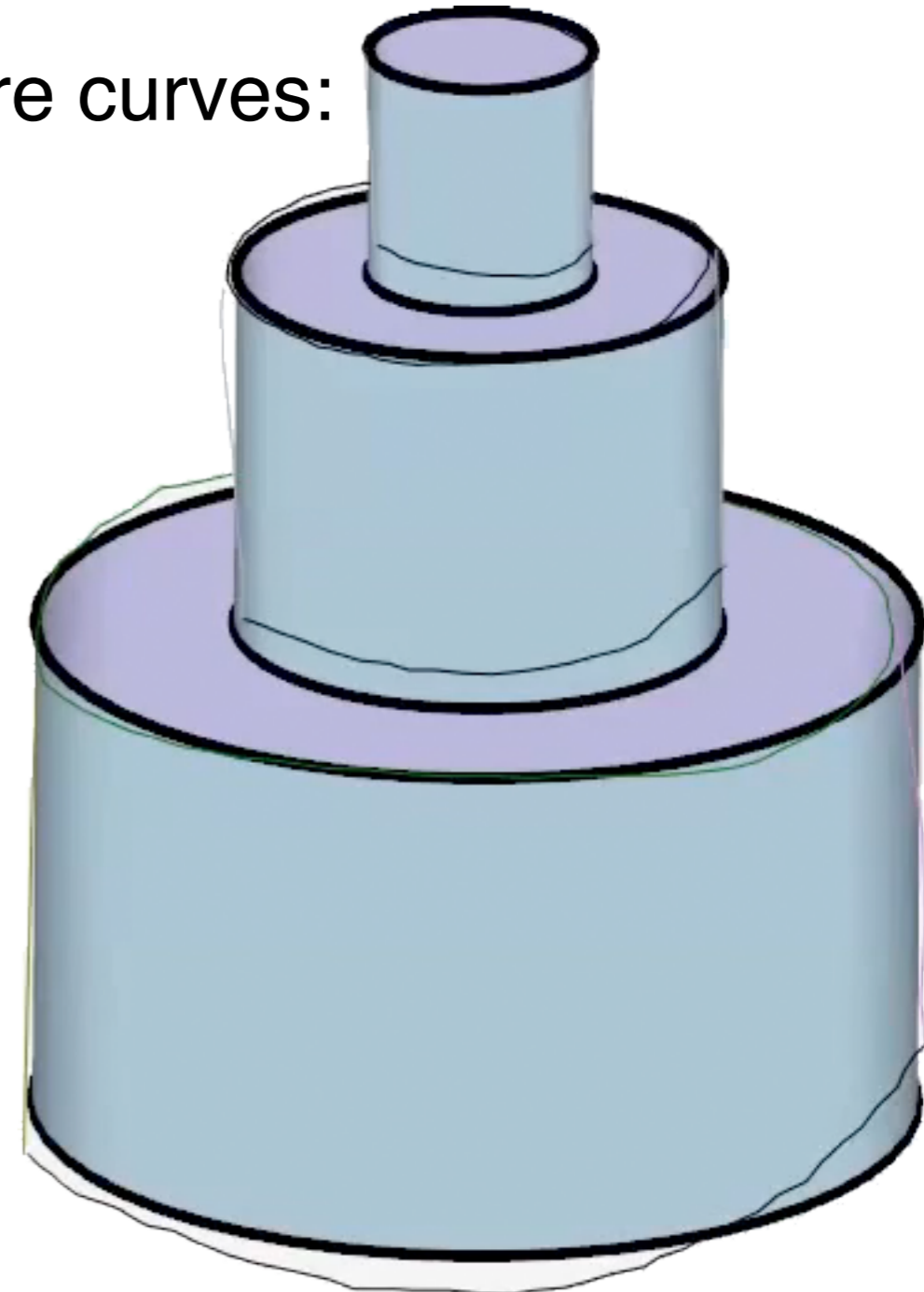

# Results



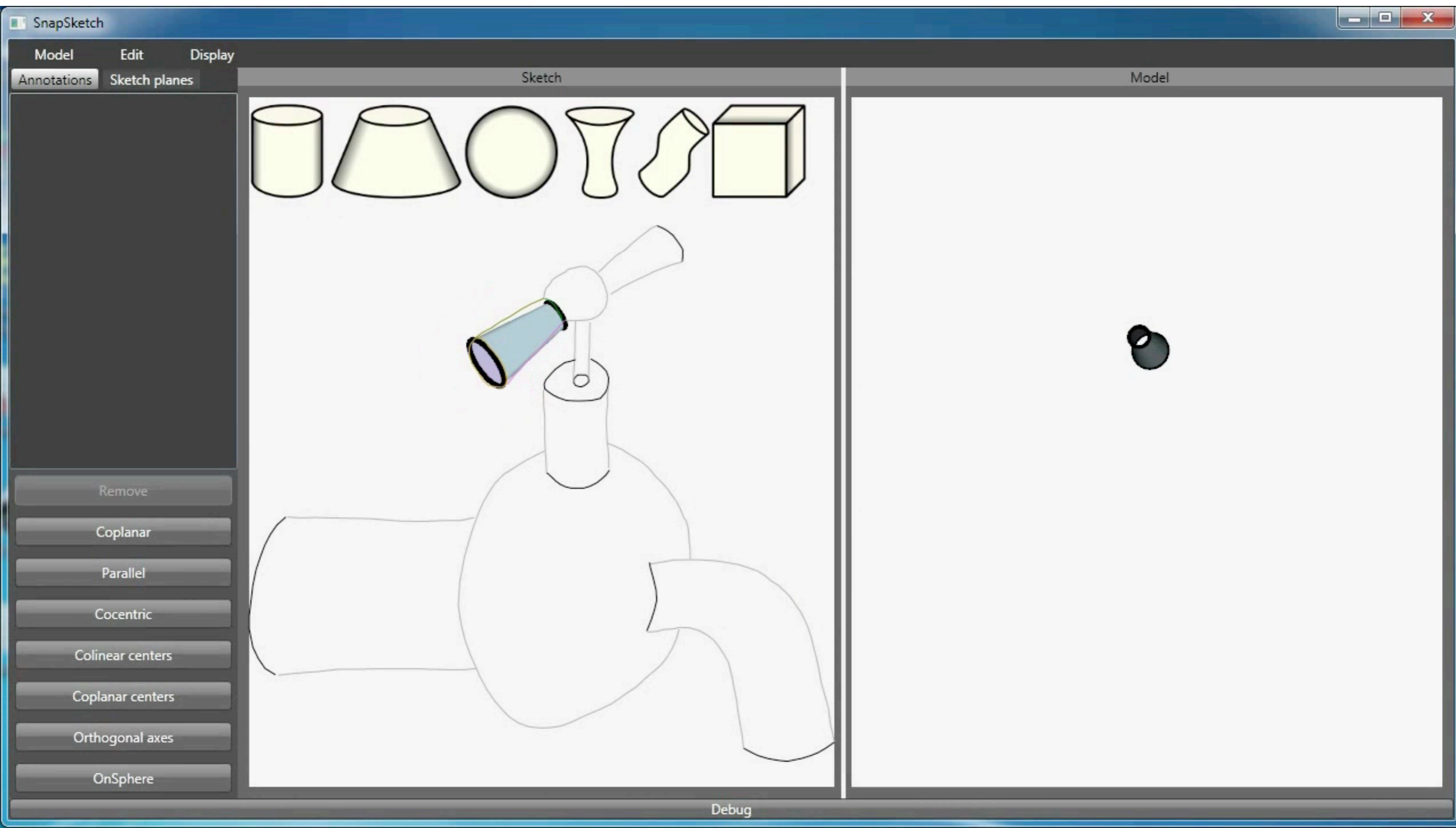

~2x

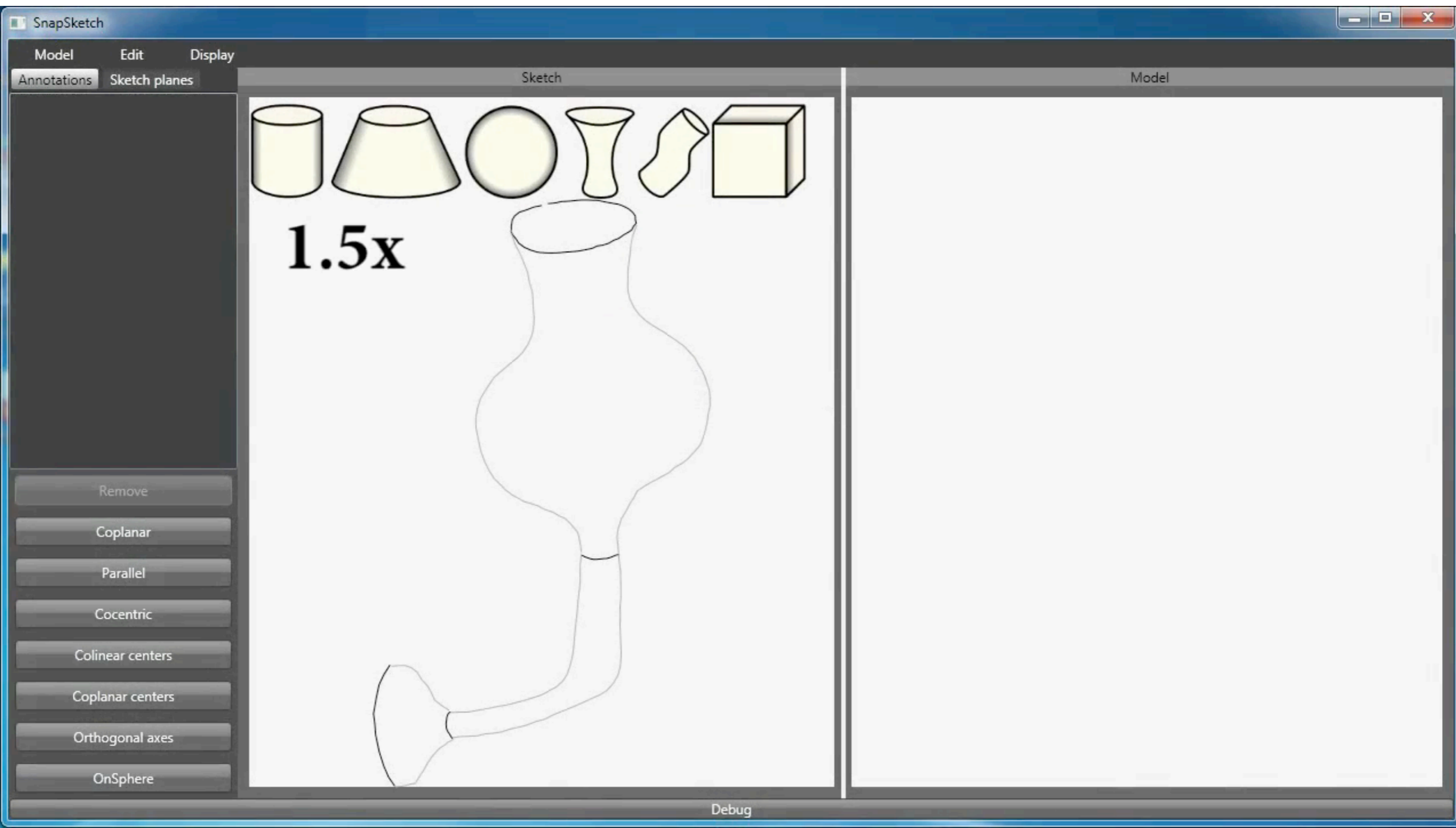

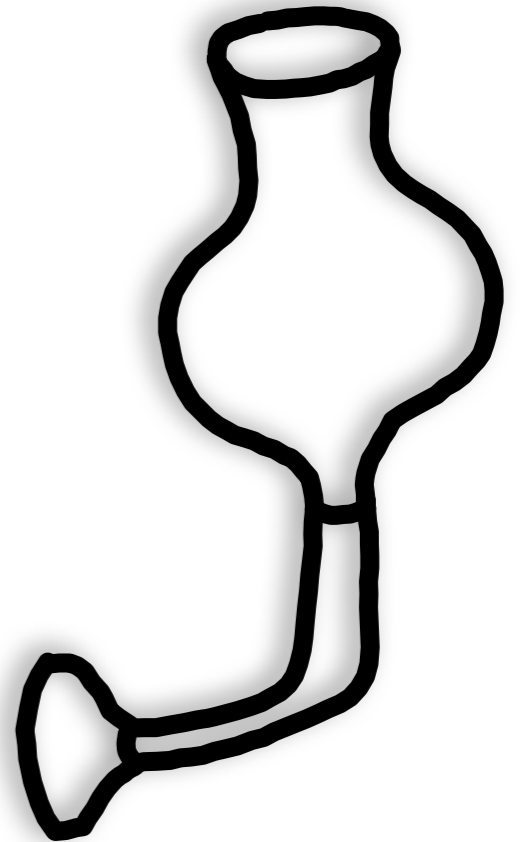
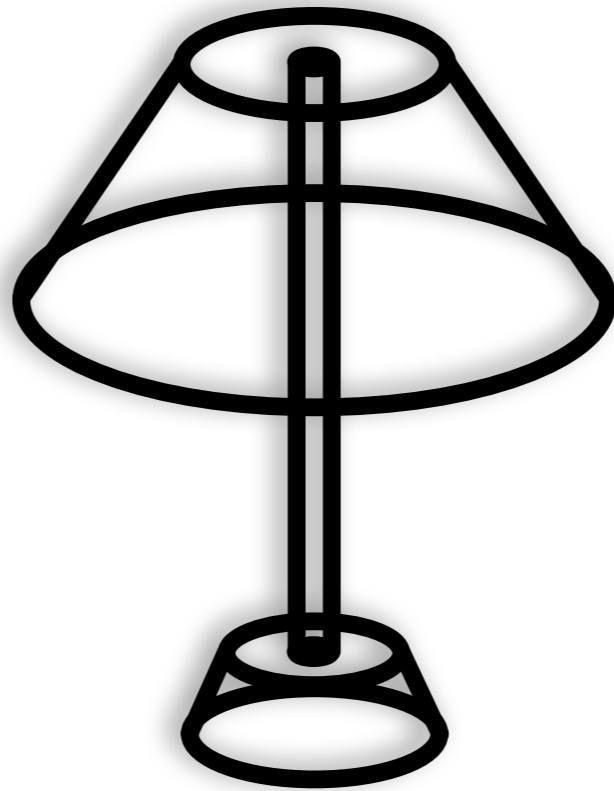
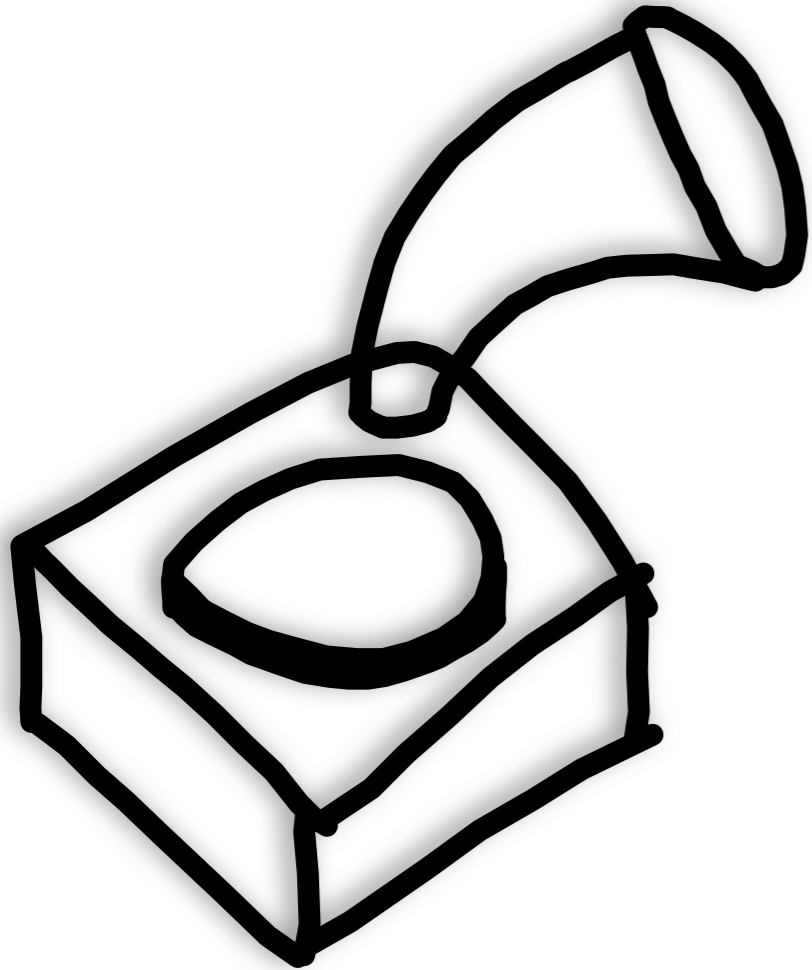
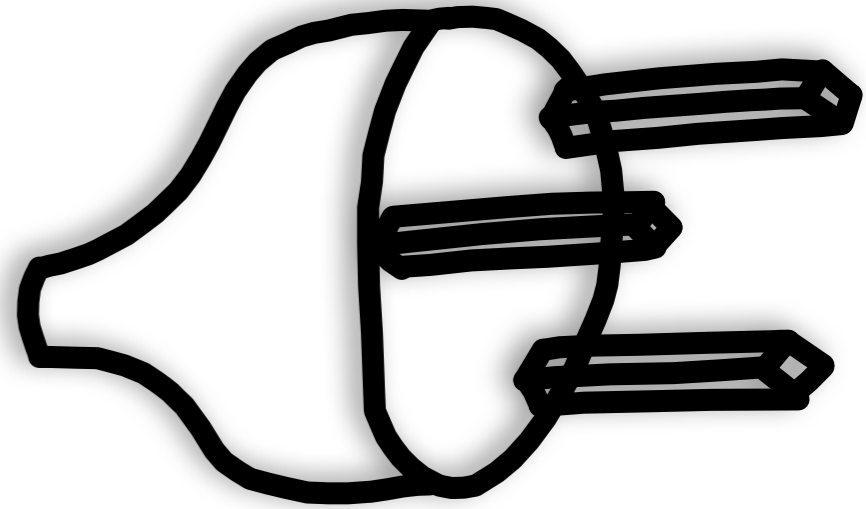
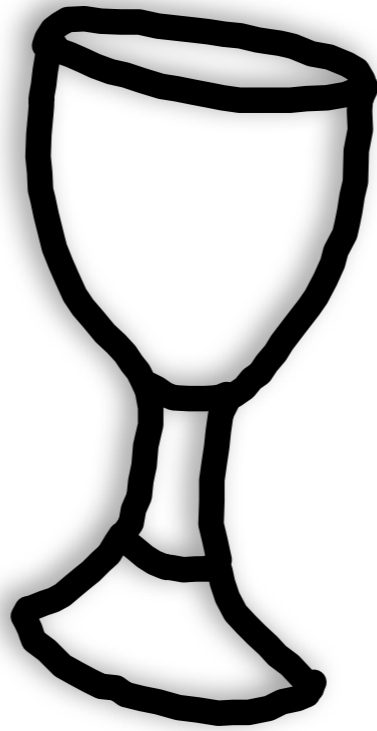

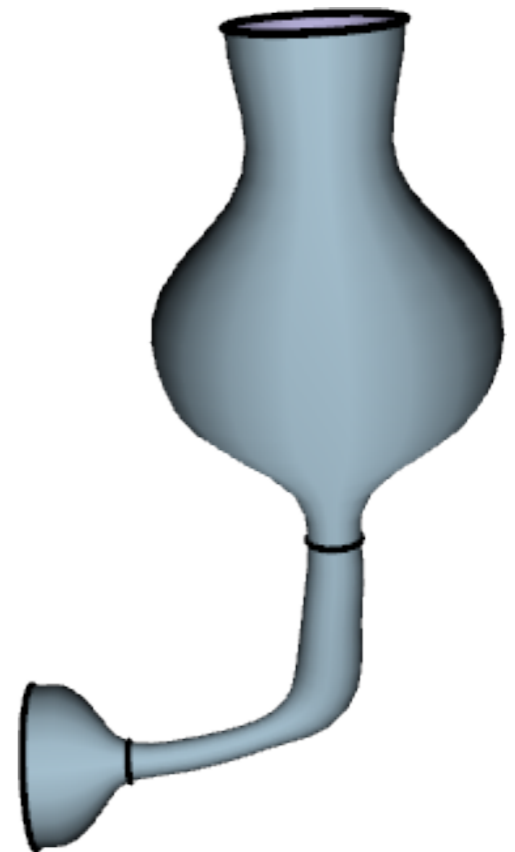
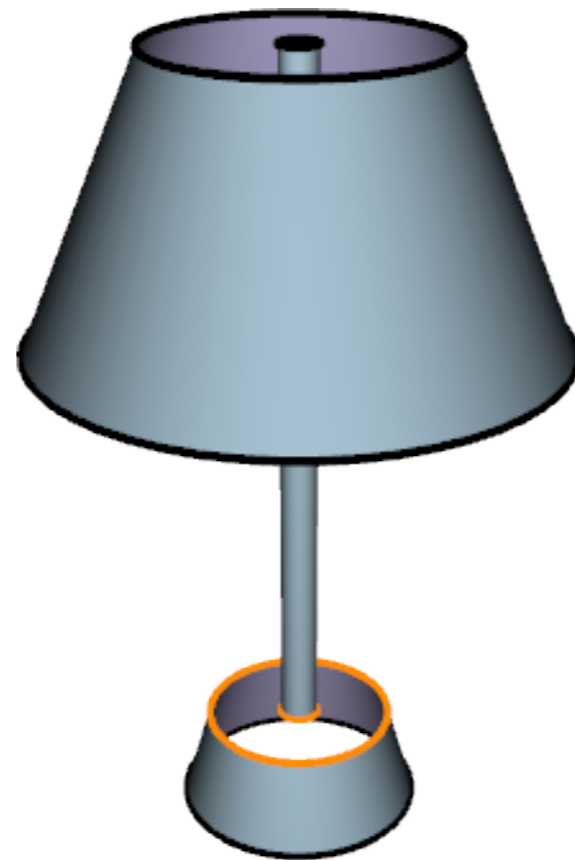
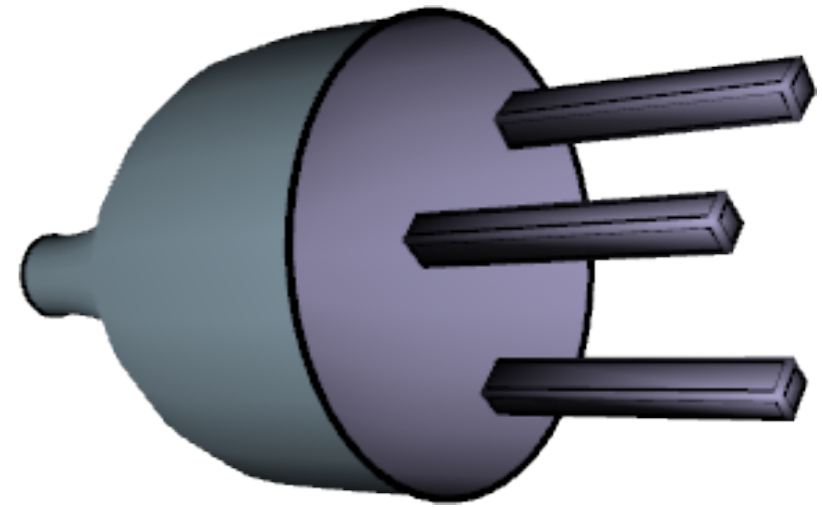
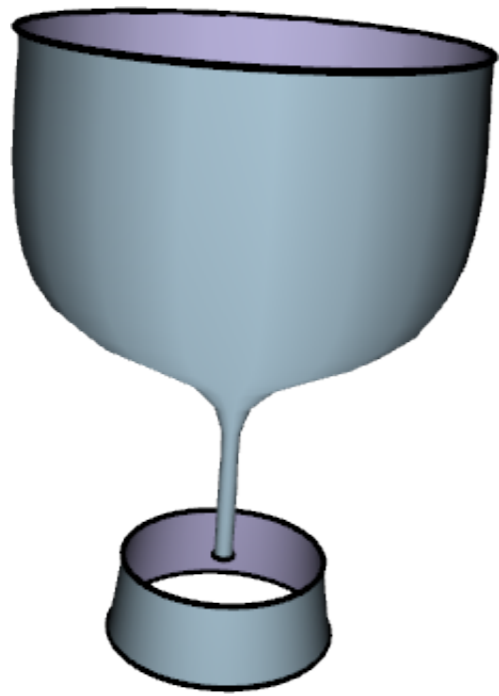

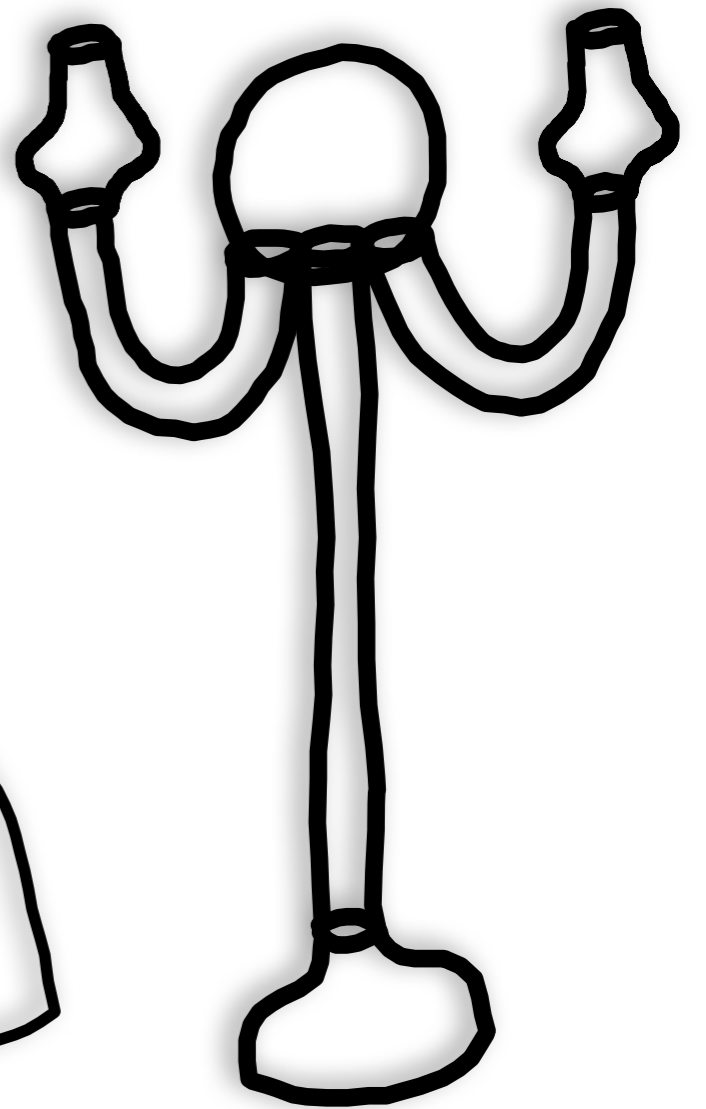
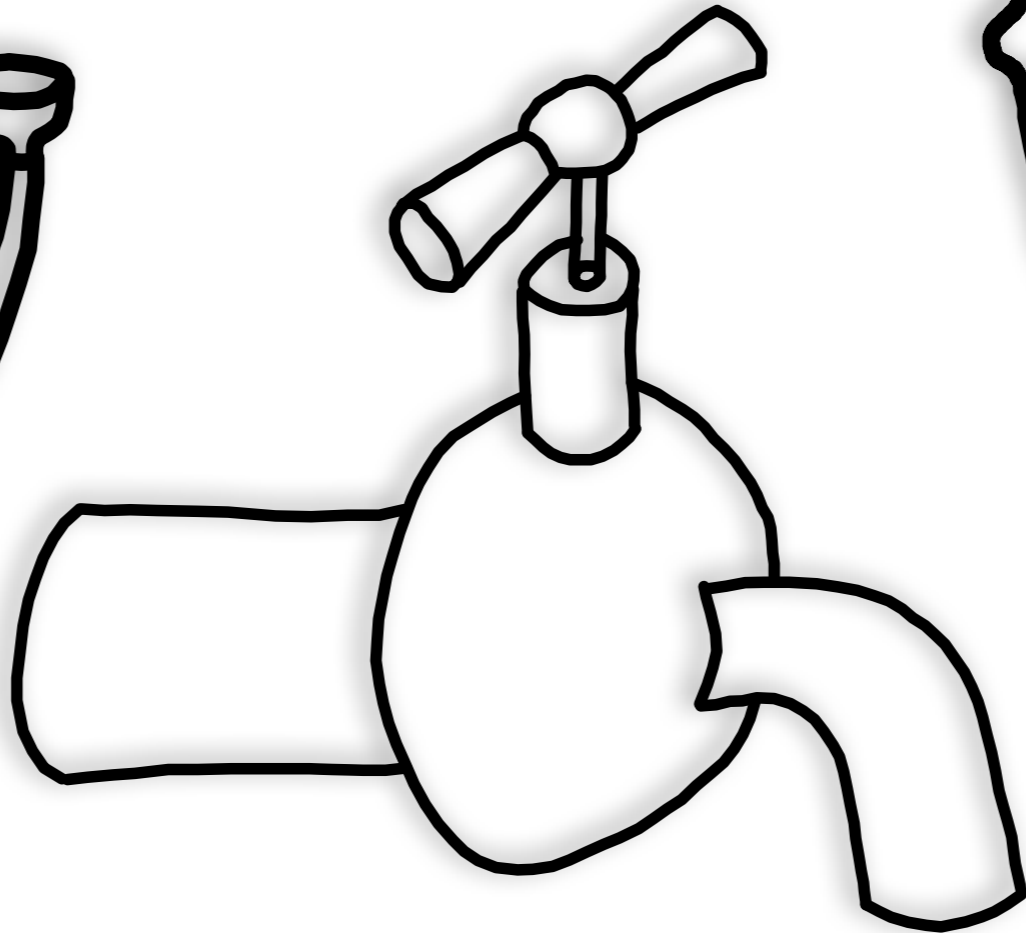
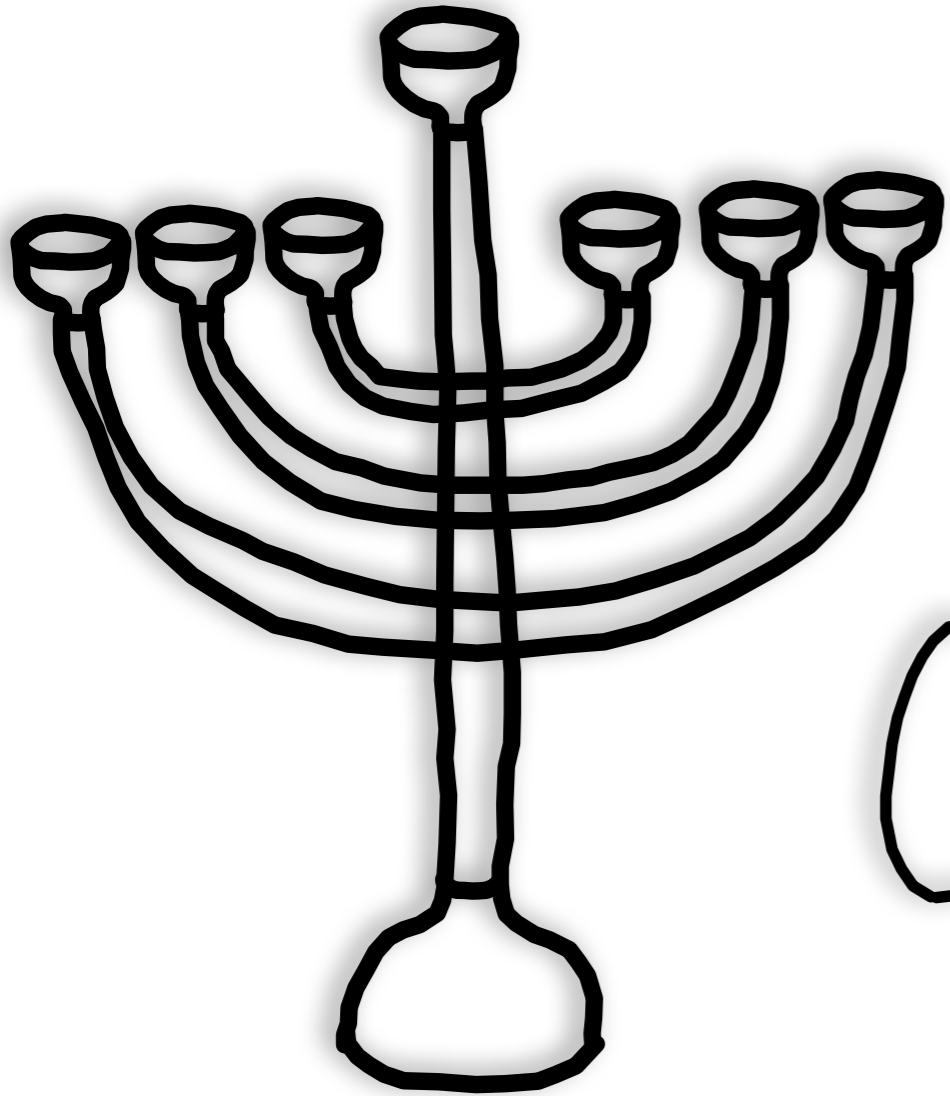
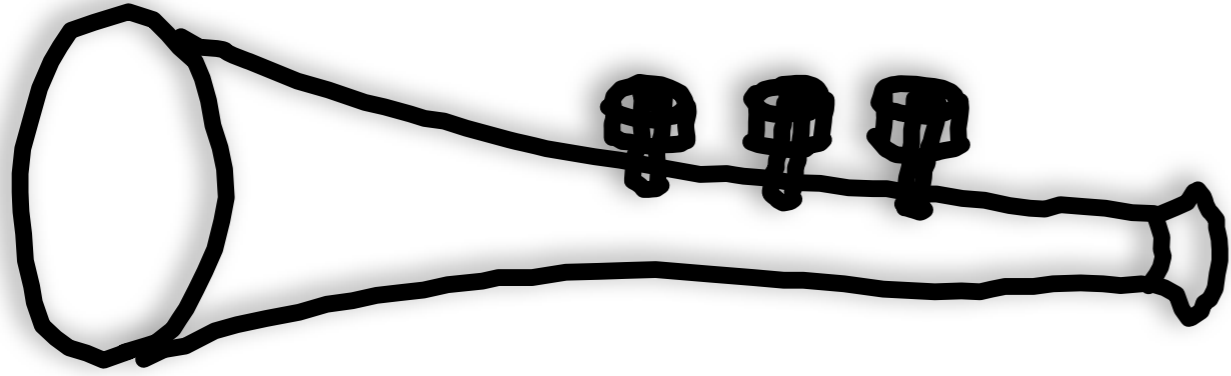

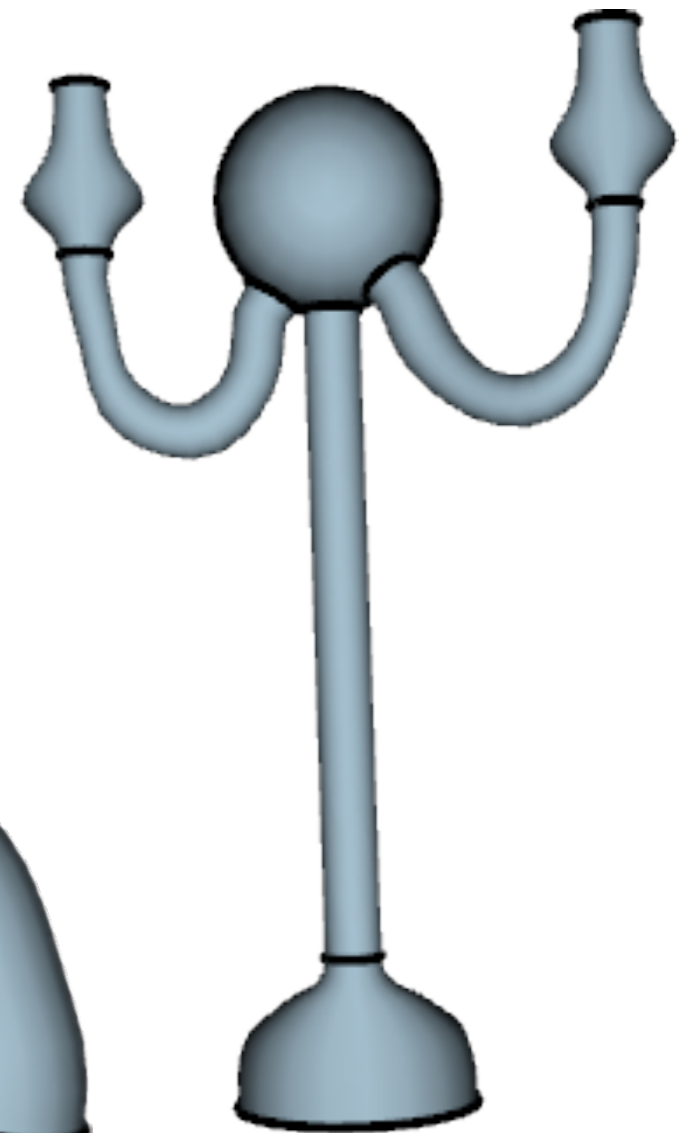
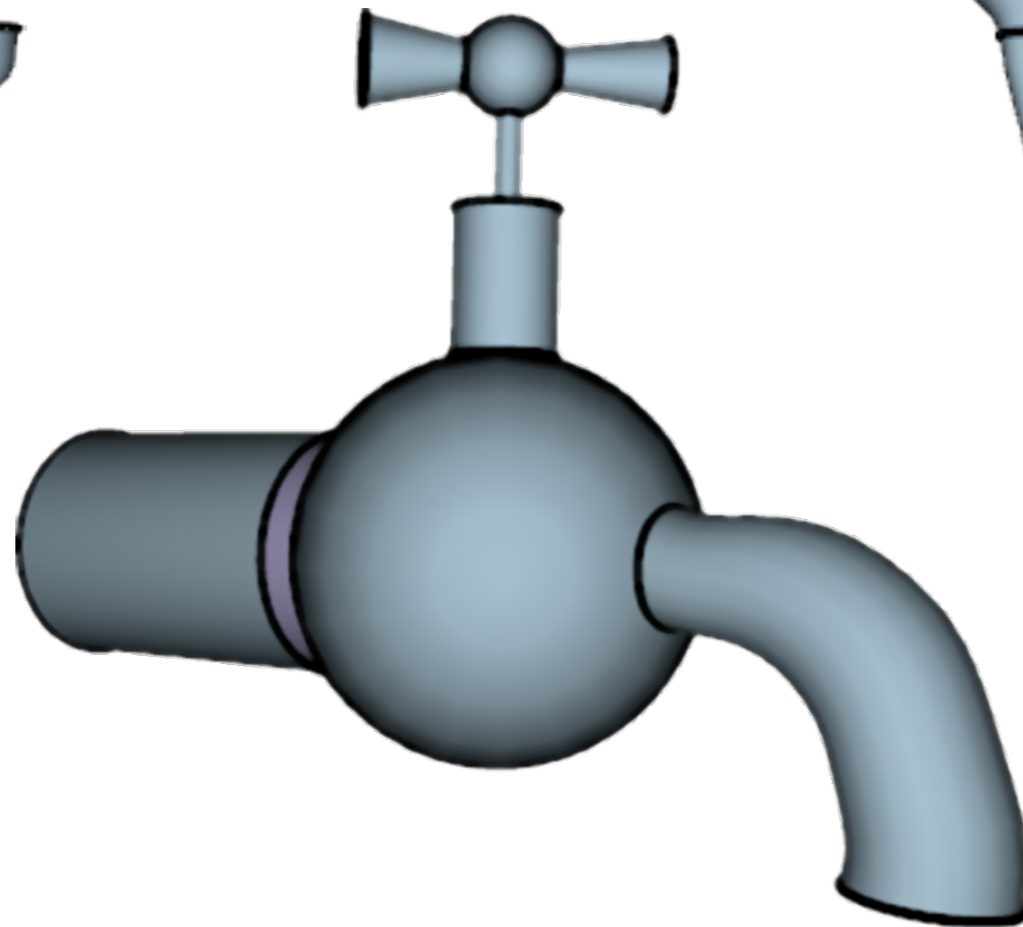
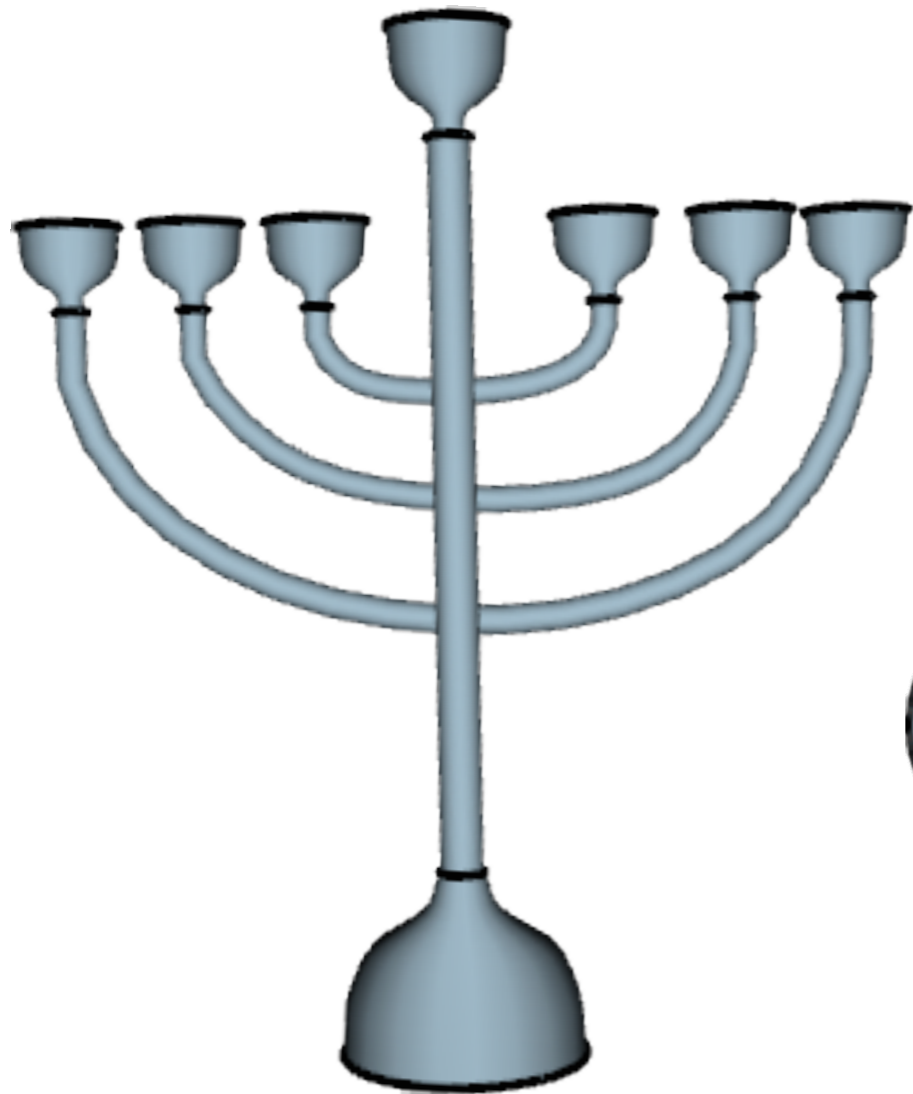
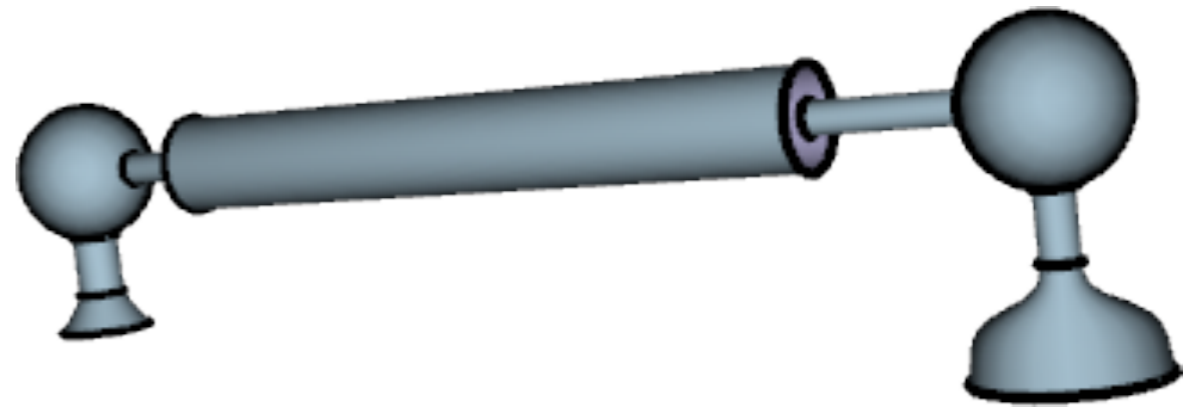
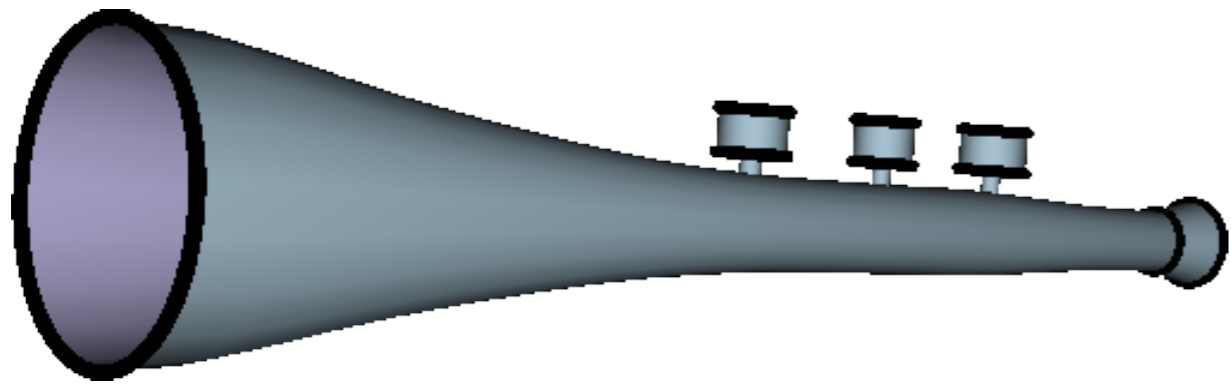

# User Study

10 users (5 female/5 male)

20 minute tutorial

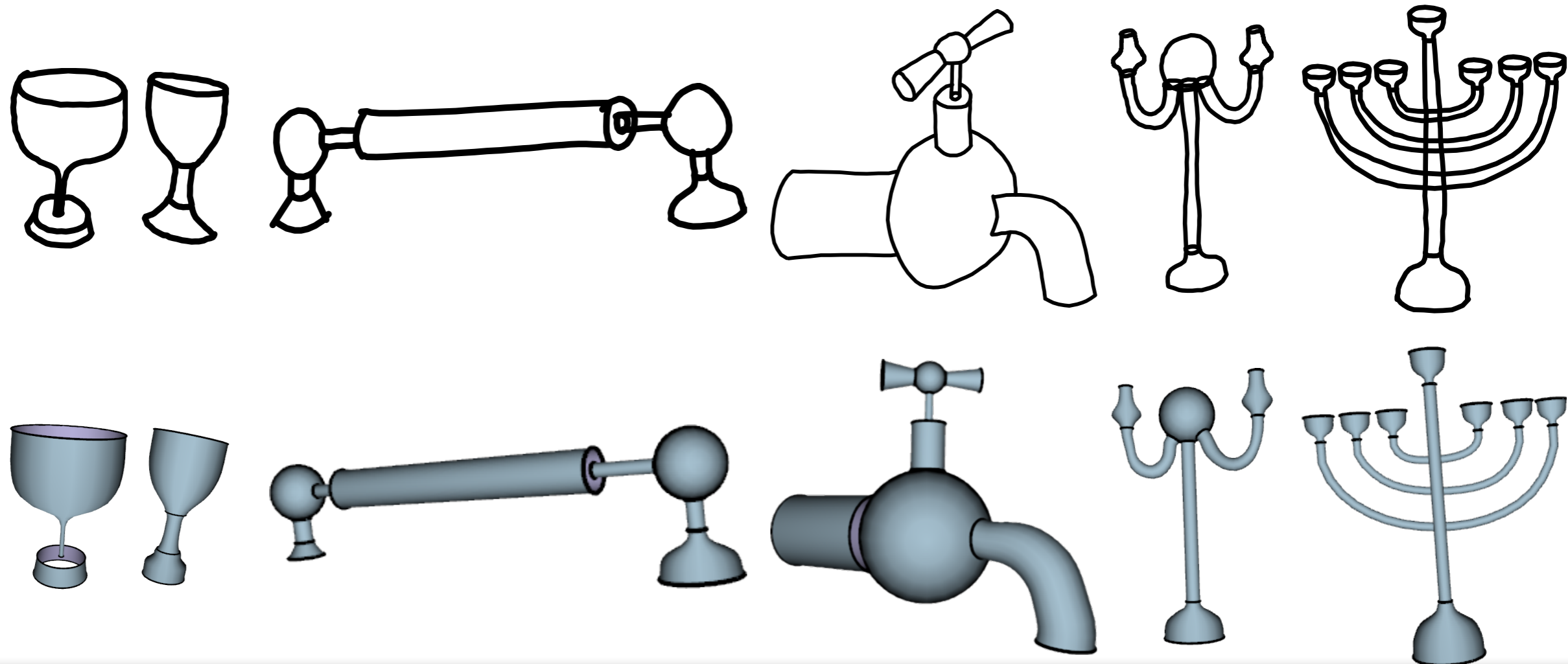

# User Study

10 users (5 female/5 male)

20 minute tutorial

Tagging took less than a minute (on average)

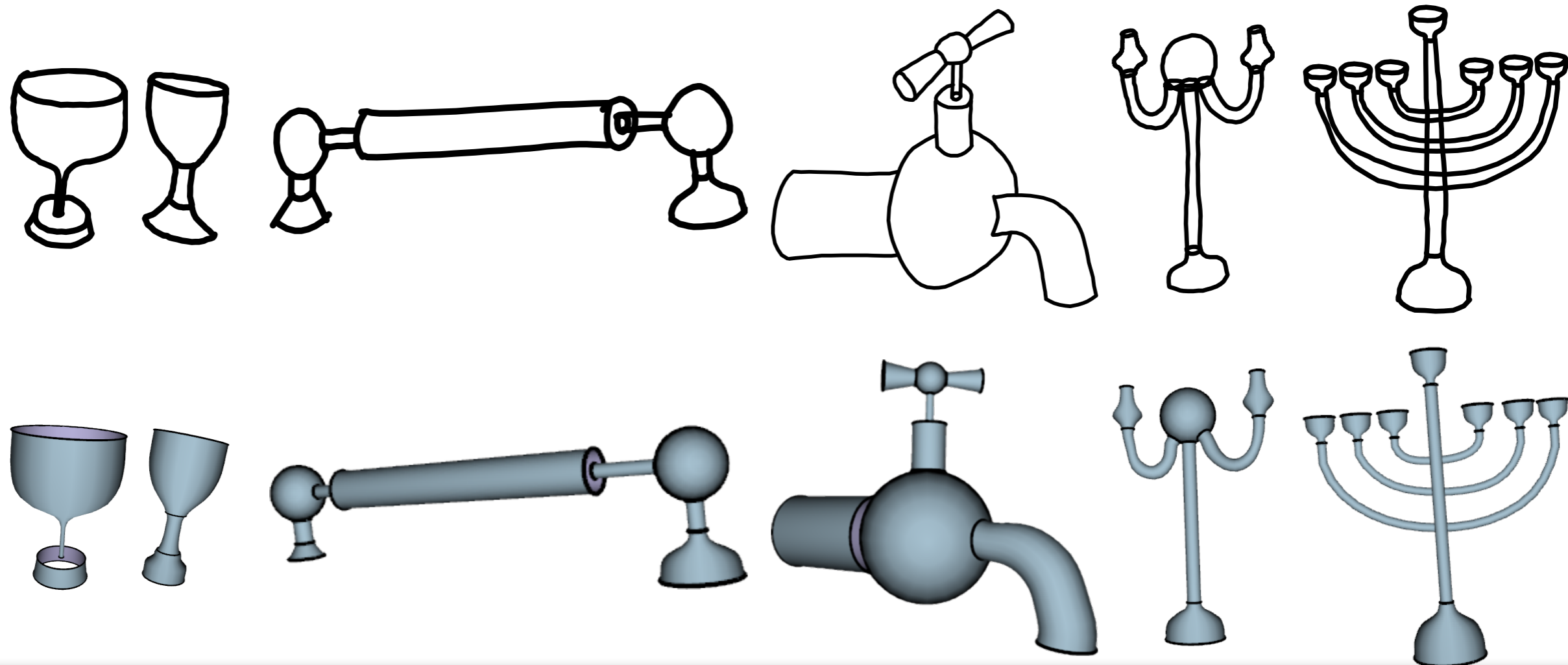



# User Study

10 users (5 female/5 male)

20 minute tutorial

Tagging took less than a minute (on average)

Drag-and-drop modeling took (average and median):

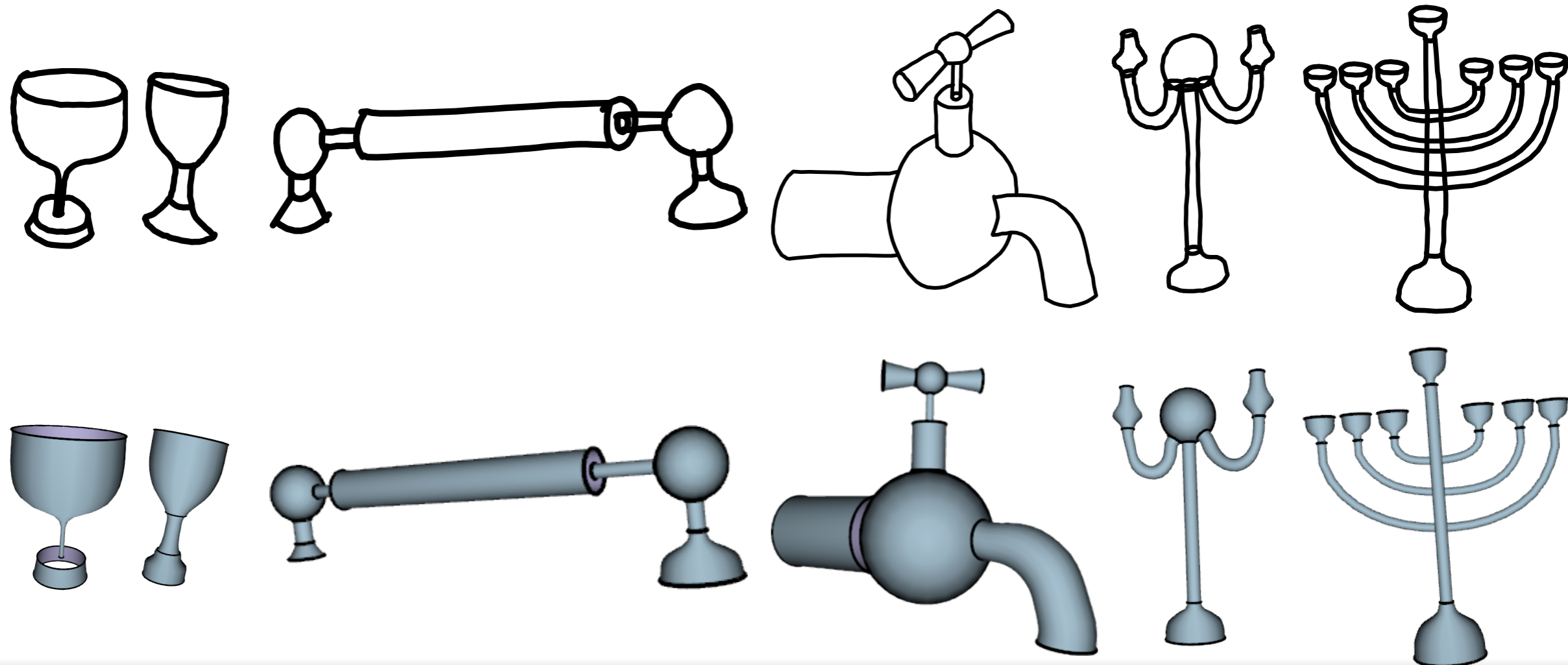

# User Study

10 users (5 female/5 male)

20 minute tutorial

Tagging took less than a minute (on average)

Drag-and-drop modeling took (average and median):

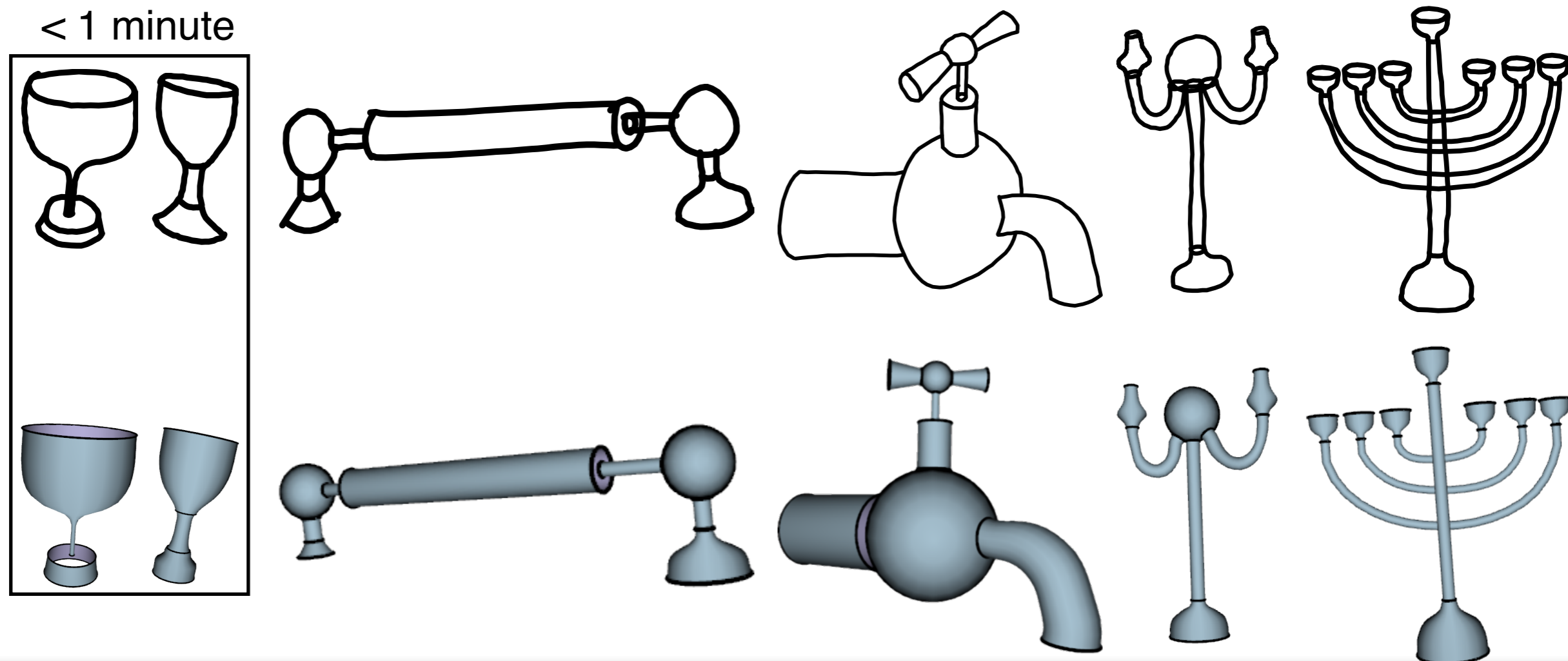

# User Study

10 users (5 female/5 male)

20 minute tutorial

Tagging took less than a minute (on average)

Drag-and-drop modeling took (average and median):

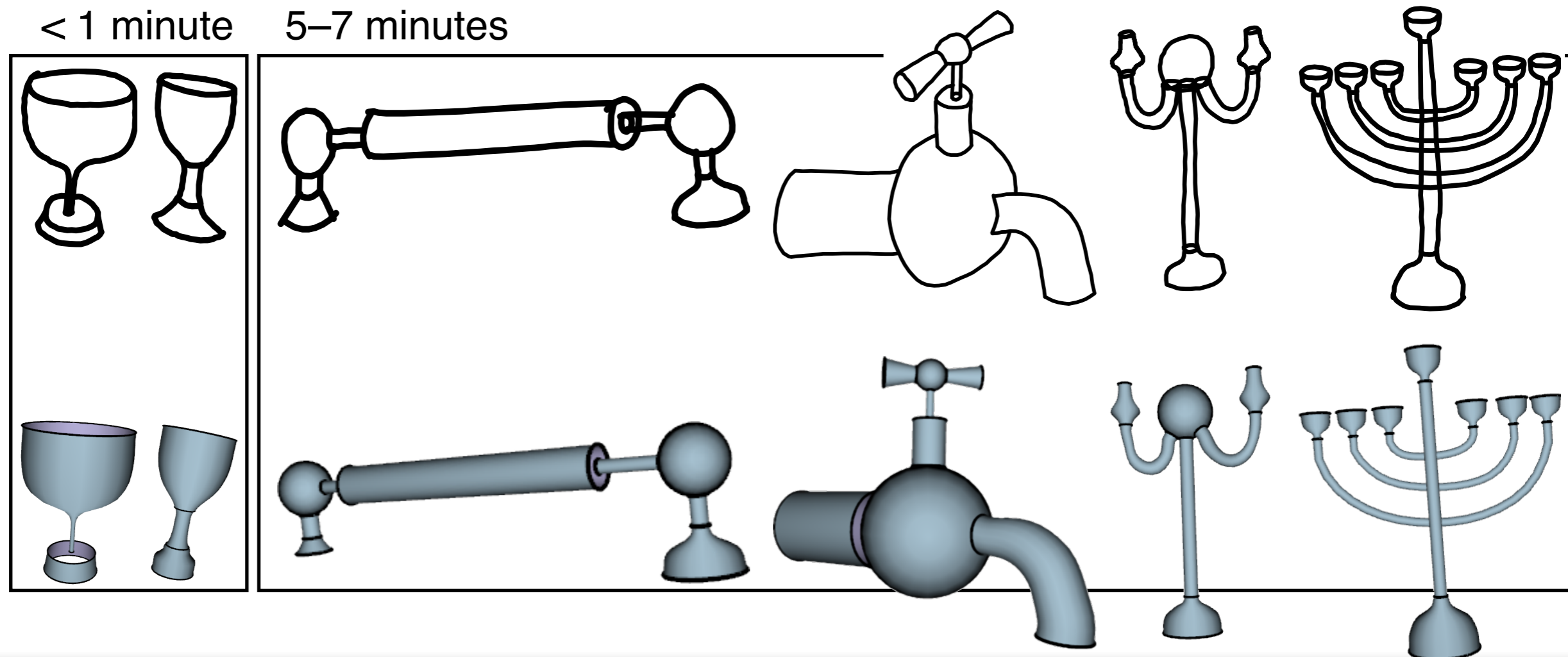

# Limitations & Future Work

# Limitations & Future Work

More primitives

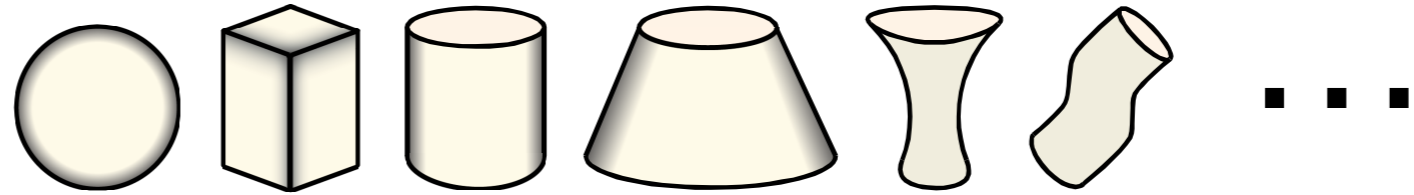

# Limitations & Future Work

More primitives

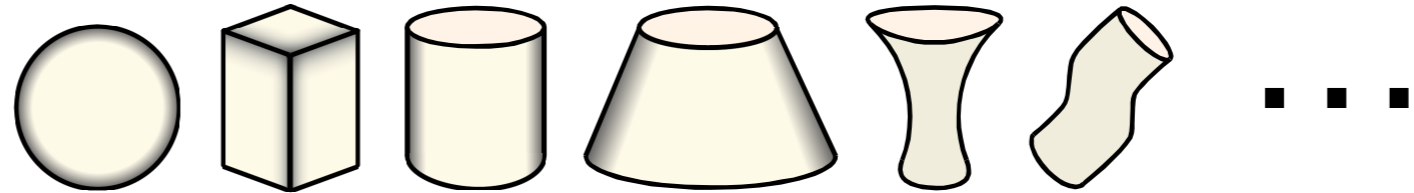

Operate directly on raster sketches

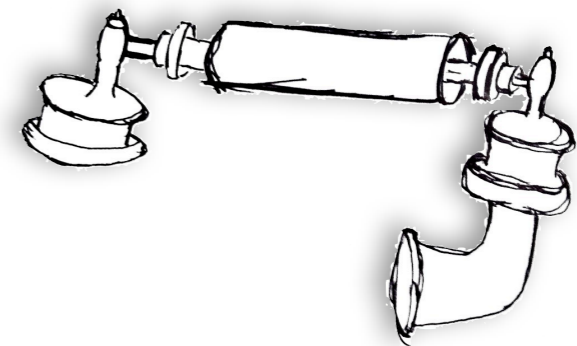

Eliminate sketch curve classification

# Limitations & Future Work

More primitives

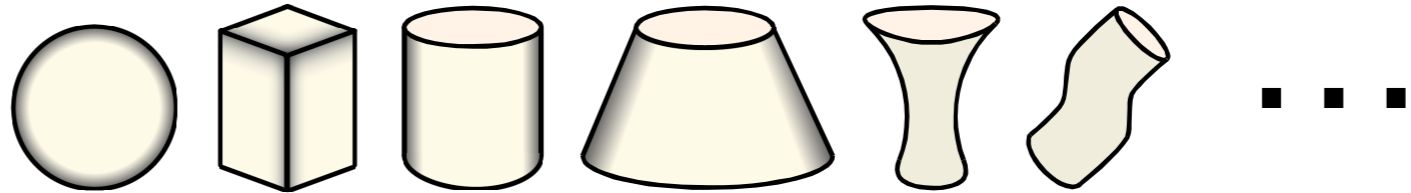

Operate directly on raster sketches

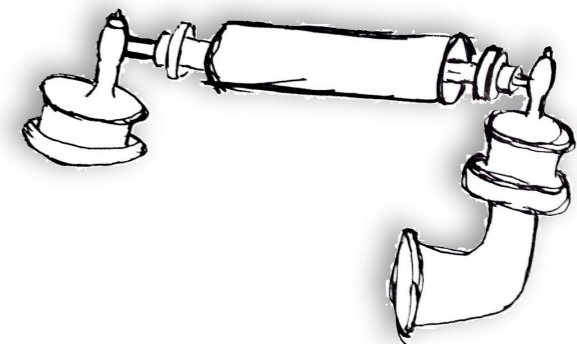

Eliminate sketch curve classification

Sketched occlusions

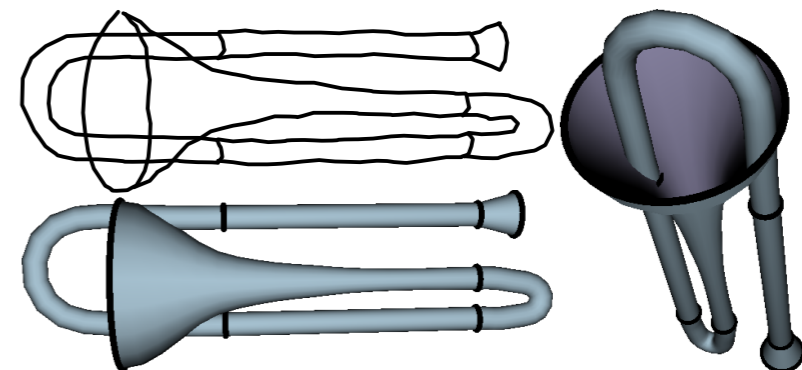

More geosemantic relations

# Conclusion

We have made a highly **non-convex** problem tractable by:



# Conclusion

We have made a highly **non-convex** problem tractable by:

- Introducing an interactive solution.

# Conclusion

We have made a highly **non-convex** problem tractable by:

- Introducing an interactive solution.
- Separating that which is easy for a **human** and challenging for a **computer**.

# Conclusion

We have made a highly **non-convex** problem tractable by:

- Introducing an interactive solution.
- Separating that which is easy for a **human** and challenging for a **computer**.
- Providing a good starting point via **drag-and-drop**.

# Conclusion

We have made a highly **non-convex** problem tractable by:

- Introducing an interactive solution.
- Separating that which is easy for a **human** and challenging for a **computer**.
- Providing a good starting point via **drag-and-drop**.
- Providing a flexible collection of parameterized **primitives**.

# Conclusion

We have made a highly **non-convex** problem tractable by:

- Introducing an interactive solution.
- Separating that which is easy for a **human** and challenging for a **computer**.
- Providing a good starting point via **drag-and-drop**.
- Providing a flexible collection of parameterized **primitives**.
- Inferring **geosemantic relationships** for aligning primitives and placing them in depth.

# Thank you

Questions?

Code for our fast reverse-mode automatic differentiation is online: <http://autodiff.codeplex.com/>

This research was supported in part by the Israel Science Foundation (grant no. 324/11), Sloan Foundation, NSF (CAREER Award CCF-06-43268 and grants IIS-09-16129, IIS-10-48948, IIS-11-17257, CMMI-11-29917, IIS-09-16845), and generous gifts from Adobe, Autodesk, Intel, mental images, NVIDIA, Side Effects Software, and the Walt Disney Company.



# Manual Tagging

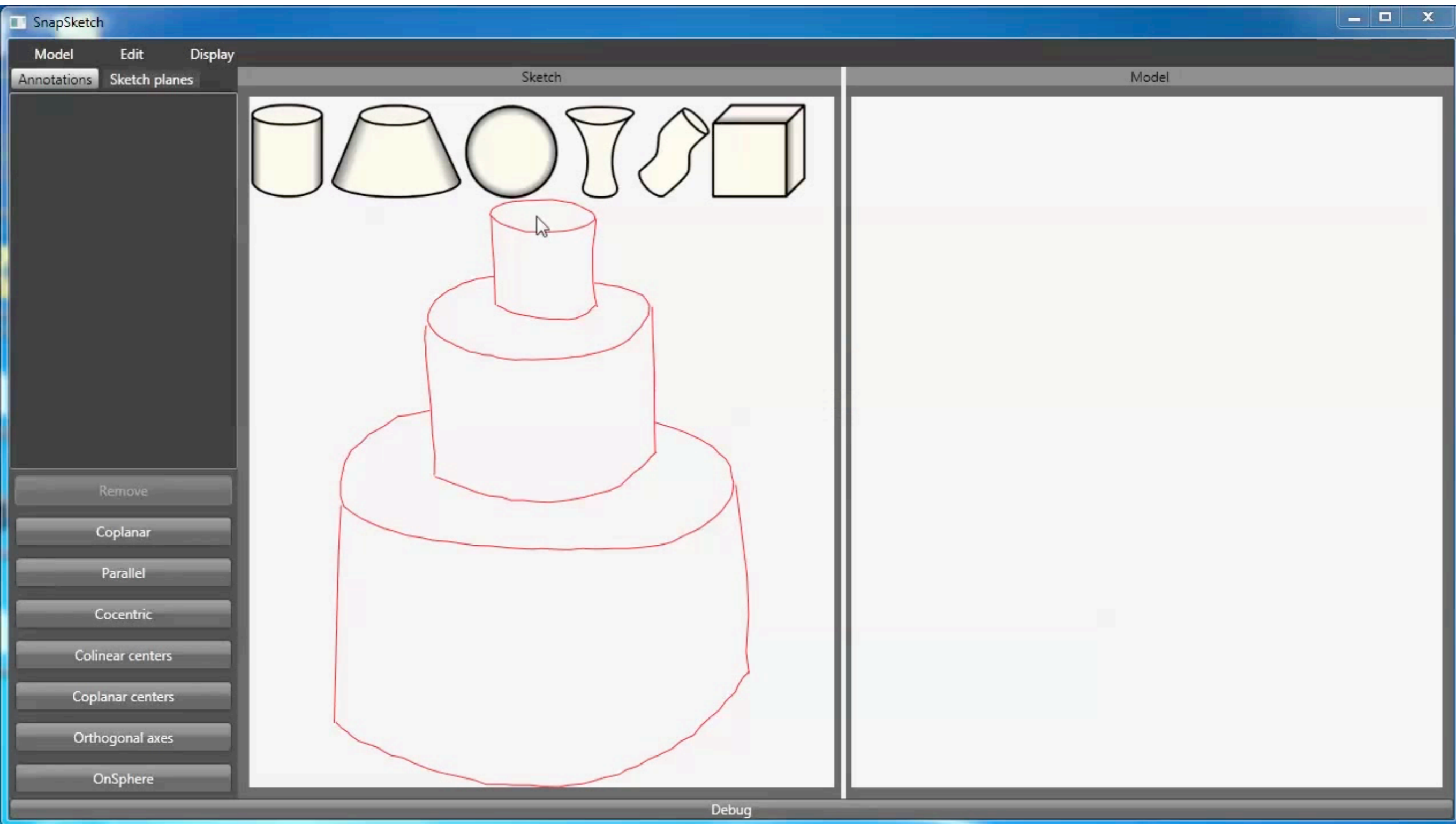

# Manual Tagging

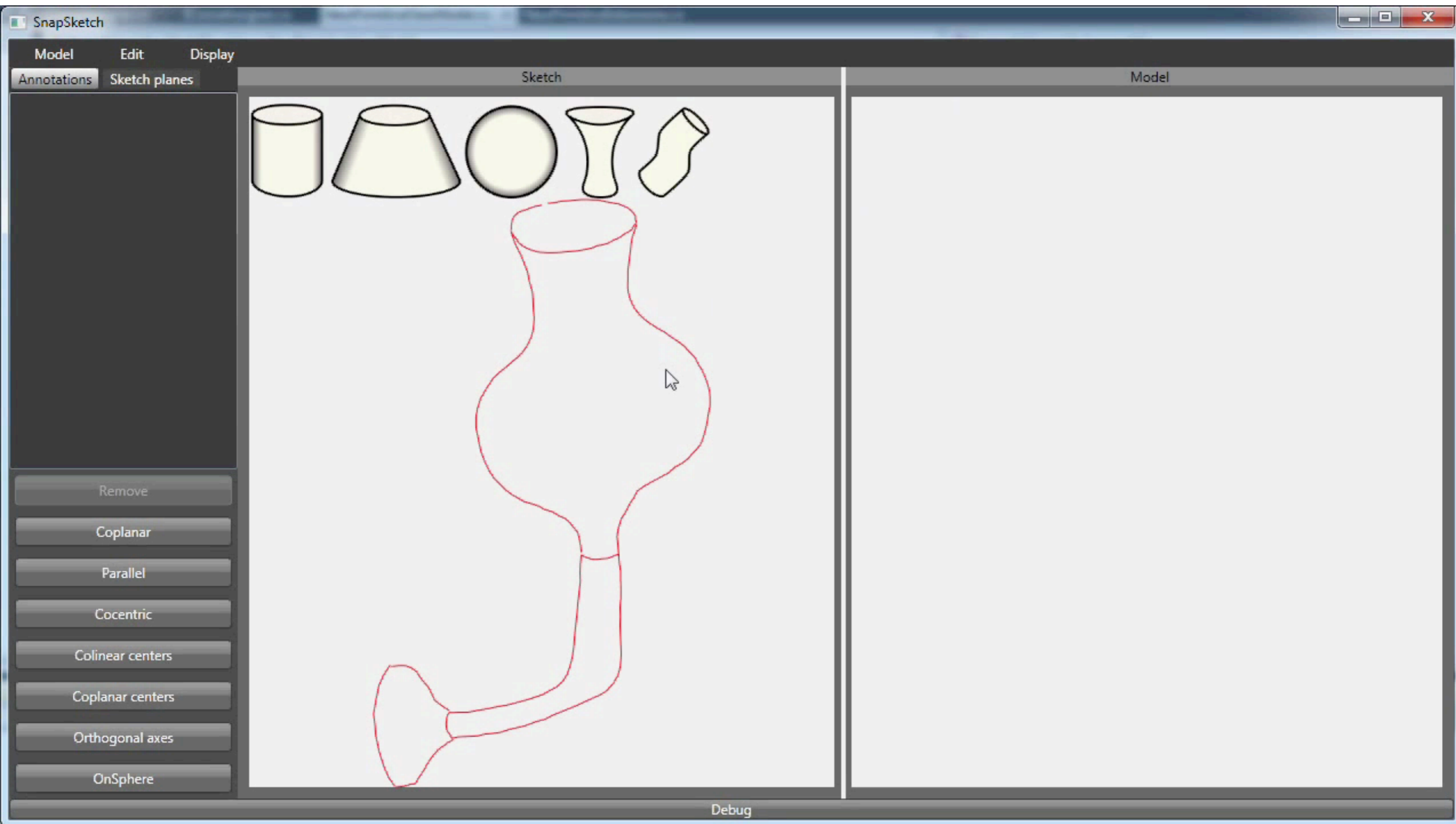



# Automatic Tagging

